

# ALPHA-STEP 200



# 084875 REV. C 9/89

---

2400 Charleston Road, Mountain View, CA 94043  
Phone: (415) 969-6767 TWX: 910-379-6436 FAX: 415-969-6371

415-969-6767



## **COPYRIGHT NOTICE**

Copyright 1986 by TENCOR INSTRUMENTS. All rights reserved worldwide. No part of this publication may be reproduced, transmitted, transcribed, stored in a retrieval system or translated into any human or computer language, in any form or by any means, electronic, mechanical, magnetic, chemical, manual, or otherwise, without the express written permission of TENCOR INSTRUMENTS, 2400 Charleston Road, Mountain View, California, 94043.

## **WARRANTY**

Except as otherwise indicated, Tencor Instruments warrants to the Buyer that the items sold by it hereunder are free from defects in material and workmanship and meet applicable specifications. In discharge of this warranty, Tencor Instruments agrees either to repair or replace as it may elect, any part or parts which under proper and normal use proves defective in material or workmanship within twelve months after delivery to Buyer. If it is recognized that some components and accessories fail to give reasonable service for a reasonable period of time, as determined solely by Tencor Instruments, Tencor Instruments will at its election replace or repair them. Tencor Instruments may at any time discharge its warranty as to any item by refunding the purchase price and taking back the item.

Unless Buyer shall inspect all items and within thirty days of delivery notify Tencor Instruments of any apparent defects discovered and shall return the apparently defective item, transportation charges prepaid, to Tencor Instrument's factory or service office if so directed, Tencor Instruments shall have no liability hereunder.

The foregoing warranty and remedy are exclusive and Tencor Instruments shall have no other liability under any other warranty express or implied either in fact or by operation of law, statutory or otherwise. Tencor Instruments shall have no liability for special or consequential damages of any kind and from any cause arising out of the installation or use of any item.

## **TRADEMARKS**

Alpha-Step 200 and Alpha-Link are trademarks of Tencor Instruments.

IBM PC, PC-XT, PC-AT, and PC-DOS are trademarks, of International Business Machines Corporation.

Epson, MX-80, RX-80 and FX-80 are trademarks of Epson America, Inc.





# TABLE OF CONTENTS

TABLE OF FIGURES.....	i
SECTION 1 -INTRODUCTION.....	3
1.1 DESCRIPTION.....	3
1.2 SPECIFICATIONS.....	10
VERTICAL RANGES.....	10
HORIZONTAL RANGES.....	10
RESOLUTION.....	10
STYLUS.....	10
STYLUS TRACKING FORCE.....	11
MAXIMUM SAMPLE DIMENSIONS.....	11
SAMPLE STAGE MOVEMENT.....	11
SCAN METHOD.....	11
SAMPLE LEVELING.....	11
DISPLAY.....	11
OUTPUT.....	11
PRINTER.....	12
DIMENSIONS.....	12
VOLTAGE.....	12
SECTION 2 - INSTALLATION.....	13
2.1 STANDARD CONFIGURATION.....	13
UNPACKING.....	13
OPERATING ENVIRONMENT.....	14
SET-UP.....	14
2.2 X-Y PROGRAMMABLE OPTION.....	16
CONNECTIONS.....	16
VACUUM CHUCK.....	16
SECTION 3 - TUTORIAL.....	17
3.1 LOADING THE SAMPLE.....	17
3.2 VIEWING AND POSITIONING THE SAMPLE.....	19
3.3 THE SCAN.....	20
3.4 READING AND PRINTING THE DATA.....	20
SECTION 4 - OPERATION.....	24
4.1 SETTING THE SCAN PARAMETERS.....	24
SCAN LENGTH AND SAMPLING DENSITY.....	28
SCAN DIRECTION.....	29
VERTICAL UNITS (KÅ OR $\mu\text{m}$ MODE).....	30
4.2 THE SCAN.....	32
POSITIONING THE SAMPLE.....	32
CONTROLLING THE SAMPLE TABLE.....	32



VIEWING THE SAMPLE.....	34
MOVING THE SAMPLE.....	35
INITIATING THE SCAN.....	35
4.3 DATA.....	37
MEASURING PROFILE FEATURES.....	37
CURSOR POSITIONING.....	38
PLOTTING INDIVIDUAL PROFILE FEATURES.....	40
OVERRIDING VERTICAL AUTORANGE.....	42
VERTICAL CENTERING.....	43
ENTERING ID NUMBERS.....	44
PRINTING OR SENDING DATA.....	45
SCREEN.....	45
SUMMARY DATA.....	45
DATA SEND.....	45
PROGRAMMED FUNCTIONS.....	47
AVERAGE PROFILE HEIGHT (AVG).....	48
TOTAL INDICATED RUNOUT (TIR).....	50
ROUGHNESS (RA).....	51
AREA.....	52
AVERAGE DIFFERENCE MODE.....	53
REPETITIVE SCANS IN AVERAGE DIFFERENCE MODE.....	55
4.4 LEVELING.....	56
LEVELING A COMPLETED SCAN.....	56
PRE-POSITIONING THE LEVELING CURSORS.....	58
ABORTING COMPUTED LEVELING.....	59
ABORTING AUTOLEVELING.....	59
RESTORING AUTOLEVELING.....	60
TECHNICAL LEVELING ADJUSTMENT.....	60
4.5 SOFTWARE FEATURES.....	62
SLOPE MEASUREMENT.....	62
MULTIPLE SCAN AND AVERAGE.....	64
PRINTER CHOICE.....	65
4.6 SETTING THE REAL-TIME CLOCK.....	67
4.7 SERIAL OUTPUT CONFIGURATION.....	68
TO CHANGE THE SERIAL OUTPUT PARAMETERS.....	68
SOFTWARE VERTICAL CALIBRATION.....	72
CALCULATING A CORRECTION FACTOR.....	72
ENTERING THE CORRECTION.....	73
CALIBRATING IN AVERAGE DIFFERENCE MODE.....	74
SECTION 5 - SERVICE AND MAINTENANCE.....	75
5.1 PRINTER PAPER CHANGE.....	75
5.2 STYLUS FORCE ADJUSTMENT.....	77
5.3 CHANGING THE STYLUS.....	79
5.4 SHIPPING THE ALPHA-STEP 200.....	81
SECTION 6 - OPERATIONAL TOPICS AND THEORY.....	82
6.1 ACCURACY CONSIDERATIONS.....	82
6.2 STYLUS SIZE.....	85
6.3 FILTERING EFFECTS.....	87
6.4 DEFEATING THE FILTER.....	87
6.5 RANGE SELECTION.....	89
SECTION 7 - PROGRAMMABLE X-Y STAGE OPTION.....	92
7.1 CONTROLS.....	94

7.1 CONTROLS.....	94
STAGE.....	94
KEYBOARD.....	95
7.2 SUBSTRATE LOCATOR BLOCKS.....	97
7.3 OPERATION.....	98
7.4 SUBSTRATE LOADING/UNLOADING.....	98
7.5 SCANNING - MANUAL MODE.....	99
7.6 PROGRAMMING.....	100
7.7 PROGRAMMING A LOCATION.....	102
7.8 ERASING A PROGRAMMED LOCATION.....	103
7.9 CHANGING A PROGRAMMED LOCATION.....	103
7.10 SCANNING.....	103
SEMIAUTOMATIC MODE.....	103
AUTOMATIC MODE.....	106
APPENDIX A - STATUS MESSAGES.....	108
PLOT MAGNIFICATION.....	108
STYLUS FORCE TOO LOW.....	108
DATA OUT OF RANGE.....	108
DATA NOT LEVELED.....	108
PRINTER DISCONNECTED.....	110
FILTER OFF.....	110
REFERENCE (OR) RAW DATA.....	110
PLEASE WAIT.....	110
APPENDIX B - ORDERING INFORMATION.....	111
OPTIONS AND ACCESSORIES.....	111
INDEX.....	115

## ADDENDUM: CROSS-SECTIONAL AREA CALCULATION

### CROSS-SECTIONAL AREA (AREA)

This addendum replaces the section, "AREA", on page 52.

The cross-sectional area of the profile, relative to a base line, is displayed in square micrometers. The base line extends between the intersections of the two measuring cursors and the profile. This line is not necessarily horizontal -- the angle depends on the positioning of the cursors and the profile.

Three options are available for this parameter: positive, negative, and total.

- **Positive (+):** Calculation of the area above the line between the intersections of the measurement cursors and the profile. Only the parts of the profile above the line are included in the measurement. Any part of the profile that dips below the line will not be counted.

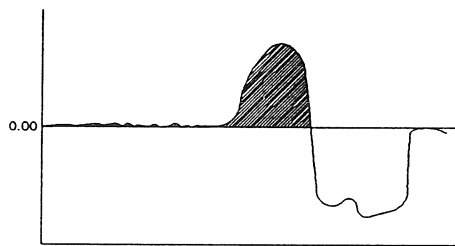

- **Negative (-):** Calculation of the area below the line between the intersections of the measurement cursors and the profile.

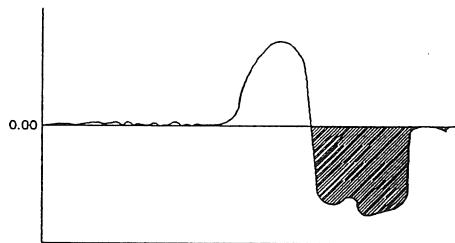

- **Total (=):** Positive and negative areas are added together.

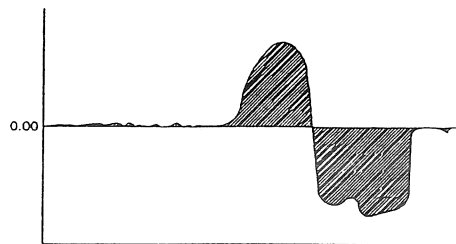

The option that you select in the Set-Up Menu will be stored and will not change until a different option is chosen. This parameter is accessed as follows.

**To select an option:**

1. Press [RESET].
2. Press [ENT].
3. Press [VID].
4. Note the "Area" field. Press [PLOT] to toggle between the three options: (+), (-), and (=).

**To view the cross-sectional area:**

1. After a scan has been taken, position the cursors in the Data Screen.
2. Press and hold [ - ] to view the baseline and area which is shaded.

Note that the "Area" value is displayed and is preceded by either +, -, or =.

## ADDENDUM: SOFTWARE VERSION 3.7

### 1. EXTRA SENSITIVITY MODE ADDED

Alpha-Step software version 3.7 can insert a pre-scan delay that might be required for extra sensitivity while measuring very small features, i.e., less than 500 Å. To access this feature, press [RESET], [ENTER], and [VID]. One of the following lines is displayed:

```
NORMAL SENS MODE   RNG ^
                   or
XSENS/DELAY MODE   RNG ^
```

You can toggle between these options by pressing [RANGE ^]. The selected option is permanently stored in the EEPROM located on the CPU card. The delay is inserted after the elevator is nulled and before the backscan begins.

The following information should be added to the figure, "Stylus Motion During Measurement," on page 36:

- (d) NORMAL SENS MODE (default) - Normal elapsed time from the starting point to when data collection begins is 3.5 seconds.
- (e) XSENS/DELAY MODE (option) - For extremely precise, small-height measurements, a longer delay time is provided: 5.5 seconds for scan times of up to 9 seconds; 18.5 seconds for scan times between 9 and 40 seconds.

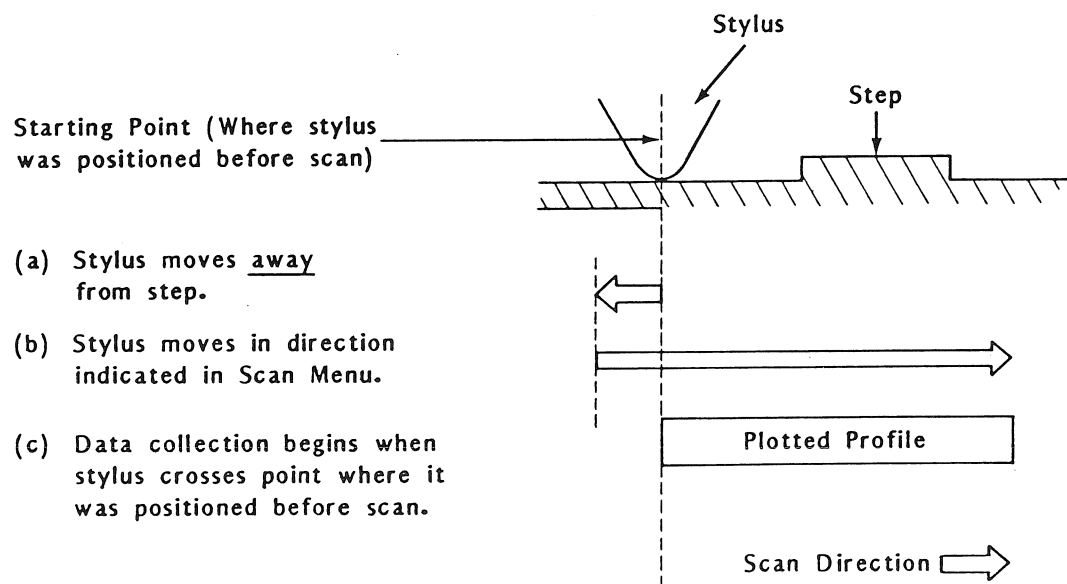

Stylus Motion During Measurement

## 2. AUTOLEVELING PROBLEM CORRECTED

A software problem with the autoleveling has been corrected in Alpha-Step software version 3.7. In previous software versions, preset autoleveling points on scan menus were not always retained when the scan menu was changed. With version 3.7, the autoleveling points that are set will be retained and displayed in the summary screen (see figure below).

## 3. PRE-POSITIONING THE LEVELING CURSORS

The following step should be added to Section 4.4, page 58, of this manual under the subheading, "Pre-positioning the Leveling Cursors." This step follows the line, "AUTOLEVELING may now be changed" and precedes the first bulleted item, "Changing the scan length . . . ."

- Set the cursors to the left and right ends of the section of the scan to be leveled. Press [ENTER]. The leveling point location will be retained and displayed in the summary screen. (See figure below.) When the scan menu is changed on the display, the cursors return to the scan ends (left and right). After changing the scan menu, the leveling cursor positions are retained in the summary screen. Press [LEVEL] to display the cursors at the leveling points.

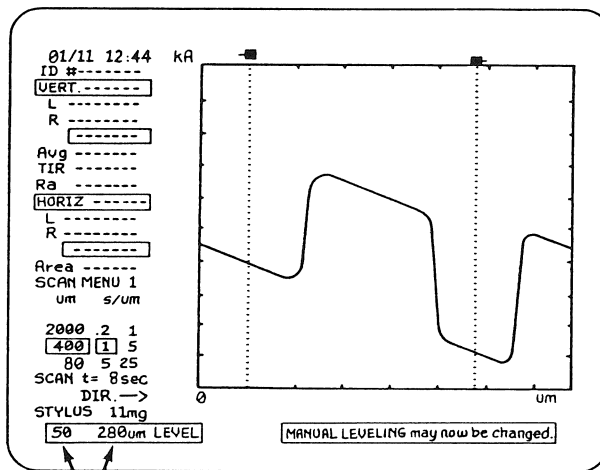

Leveling cursor  
positions  
shown here.

Move leveling  
cursors to places  
of equal height.

### Leveling the Data Display

**NOTE:** Alpha-Step software version 3.7 is available for Alpha-Step models 200, 250, and 700.



## TABLE OF FIGURES

1	The Alpha-Step 200 (Standard Configuration)	1
2	The Alpha-Step 200 (X-Y Programmable Stage Configuration)	2
3	The Alpha-Link Data Display	8
4	The Alpha-Step 200 Keyboard	9
5	The Alpha-Step 200 Printer	9
6	The Alpha-Step 200 Isolation Hood	9
7	The Alpha-Step 200 Rear Panel	14
8	Removing the Rotary Stage	15
9	Loading the Sample	18
10	Viewing the Measurement	19
11	A surface Profile Plot	21
12	Positioning Cursors to Measure Step Height	22
13	Positioning Cursors to Magnify Scan Features	23
14	Changing the Scan Menu	25
15	Selecting a Stored Scan Menu	26
16	Changing the Scan Length and Sampling Rate	28
17	Changing the Scan Direction	29
18	Changing the Vertical Units	31
19	Controlling Motion of the Stage	33
20	Stylus Motion During Measurement	36
21	Positioning the Cursors to Measure Step Height	40
22	Magnifying a Step Feature for Greater Clarity	41
23	A Printout Made in Screen Mode	46
24	Measuring the Average Profile Height	49
25	Measuring the Total Indicated Runout (TIR)	50
26	Measuring the Roughness	51
27	Measuring the Area	52
28	Computing the Average Difference	54
29	Leveling the Data Display	57
30	Mechanically Adjusting the Leveling	61
31	Locking the Cursors and Panning Across Slope	63
32	Summary Data Displays the Average Height Difference	65
33	The Serial Output Configuration	71
34	Loading Paper Into the Printer	76
35	Adjusting the Stylus Force	78
36	Changing the Stylus	79
37	A Stylus Measures a Surface Characteristic	83



## ADDENDUM: SOFTWARE VERSION 3.7

### 1. EXTRA SENSITIVITY MODE ADDED

Alpha-Step software version 3.7 can insert a pre-scan delay that might be required for extra sensitivity while measuring very small features, i.e., less than 500 Å. To access this feature, press [RESET], [ENTER], and [VID]. One of the following lines is displayed:

NORMAL SENS MODE    RNG ^  
 or  
 XSENS/DELAY MODE    RNG ^

You can toggle between these options by pressing [RANGE ^]. The selected option is permanently stored in the EEPROM located on the CPU card. The delay is inserted after the elevator is nulled and before the backscan begins.

The following information should be added to the figure, "Stylus Motion During Measurement," on page 36:

- (d) NORMAL SENS MODE (default) - Normal elapsed time from the starting point to when data collection begins is 3.5 seconds.
- (e) XSENS/DELAY MODE (option) - For extremely precise, small-height measurements, a longer delay time is provided: 5.5 seconds for scan times of up to 9 seconds; 18.5 seconds for scan times between 9 and 40 seconds.

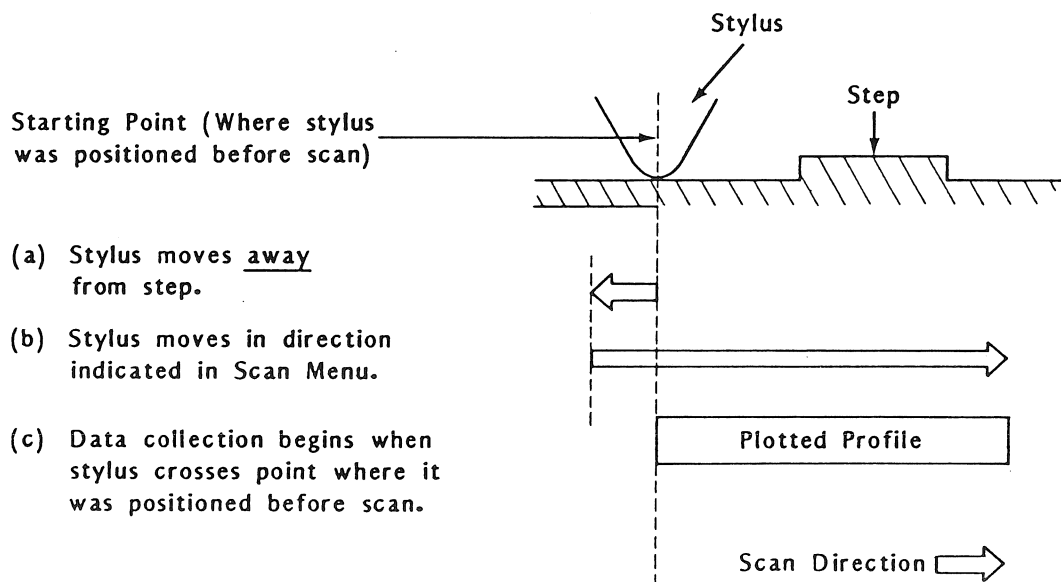

Stylus Motion During Measurement



## ADDENDUM: SOFTWARE VERSION 3.7

### 1. EXTRA SENSITIVITY MODE ADDED

Alpha-Step software version 3.7 can insert a pre-scan delay that might be required for extra sensitivity while measuring very small features, i.e., less than 500 Å. To access this feature, press [RESET], [ENTER], and [VID]. One of the following lines is displayed:

```
NORMAL SENS MODE   RNG ^
or
XSENS/DELAY MODE  RNG ^
```

You can toggle between these options by pressing [RANGE ^]. The selected option is permanently stored in the EEPROM located on the CPU card. The delay is inserted after the elevator is nulled and before the backscan begins.

The following information should be added to the figure, "Stylus Motion During Measurement," on page 36:

- (d) NORMAL SENS MODE (default) - Normal elapsed time from the starting point to when data collection begins is 3.5 seconds.
- (e) XSENS/DELAY MODE (option) - For extremely precise, small-height measurements, a longer delay time is provided: 5.5 seconds for scan times of up to 9 seconds; 18.5 seconds for scan times between 9 and 40 seconds.

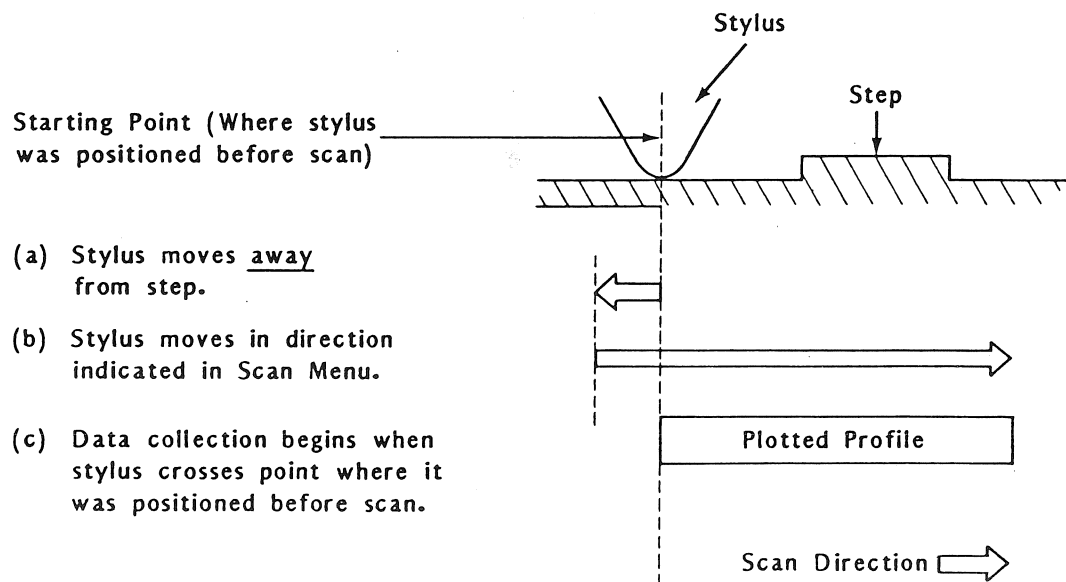

Stylus Motion During Measurement

## 2. AUTOLEVELING PROBLEM CORRECTED

A software problem with the autoleveling has been corrected in Alpha-Step software version 3.7. In previous software versions, preset autoleveling points on scan menus were not always retained when the scan menu was changed. With version 3.7, the autoleveling points that are set will be retained and displayed in the summary screen (see figure below).

## 3. PRE-POSITIONING THE LEVELING CURSORS

The following step should be added to Section 4.4, page 58, of this manual under the subheading, "Pre-positioning the Leveling Cursors." This step follows the line, "AUTOLEVELING may now be changed" and precedes the first bulleted item, "Changing the scan length . . . ."

- Set the cursors to the left and right ends of the section of the scan to be leveled. Press [ENTER]. The leveling point location will be retained and displayed in the summary screen. (See figure below.) When the scan menu is changed on the display, the cursors return to the scan ends (left and right). After changing the scan menu, the leveling cursor positions are retained in the summary screen. Press [LEVEL] to display the cursors at the leveling points.

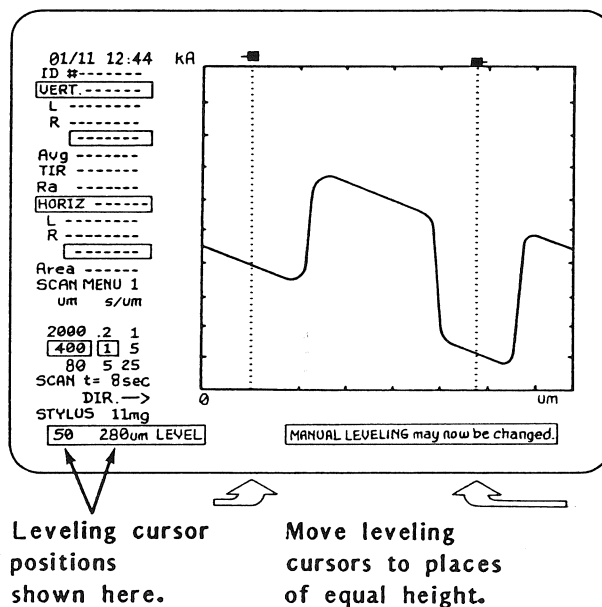

Leveling the Data Display

**NOTE:** Alpha-Step software version 3.7 is available for Alpha-Step models 200, 250, and 700.

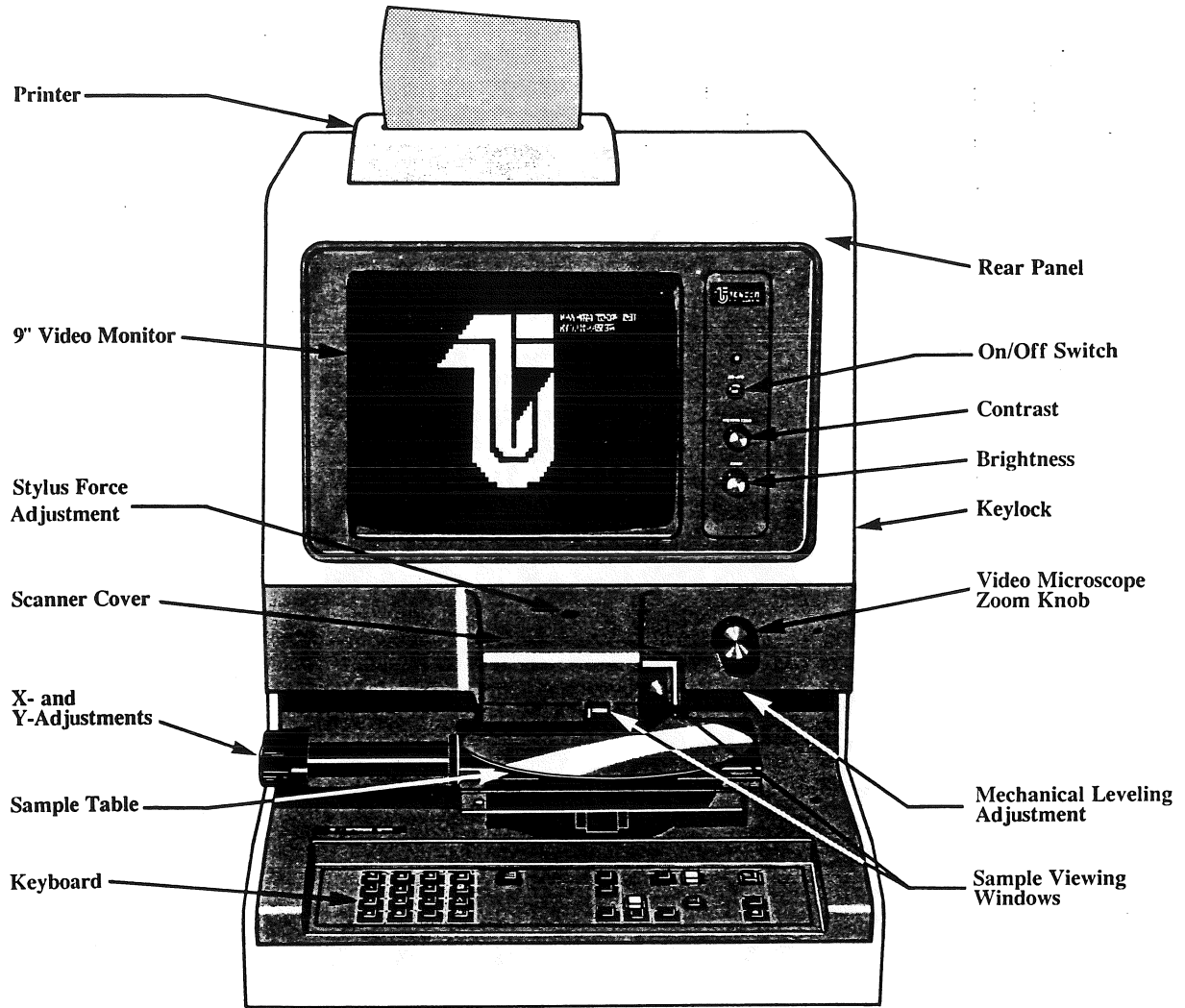

Figure 1: The Alpha-Step 200 (Standard Configuration)

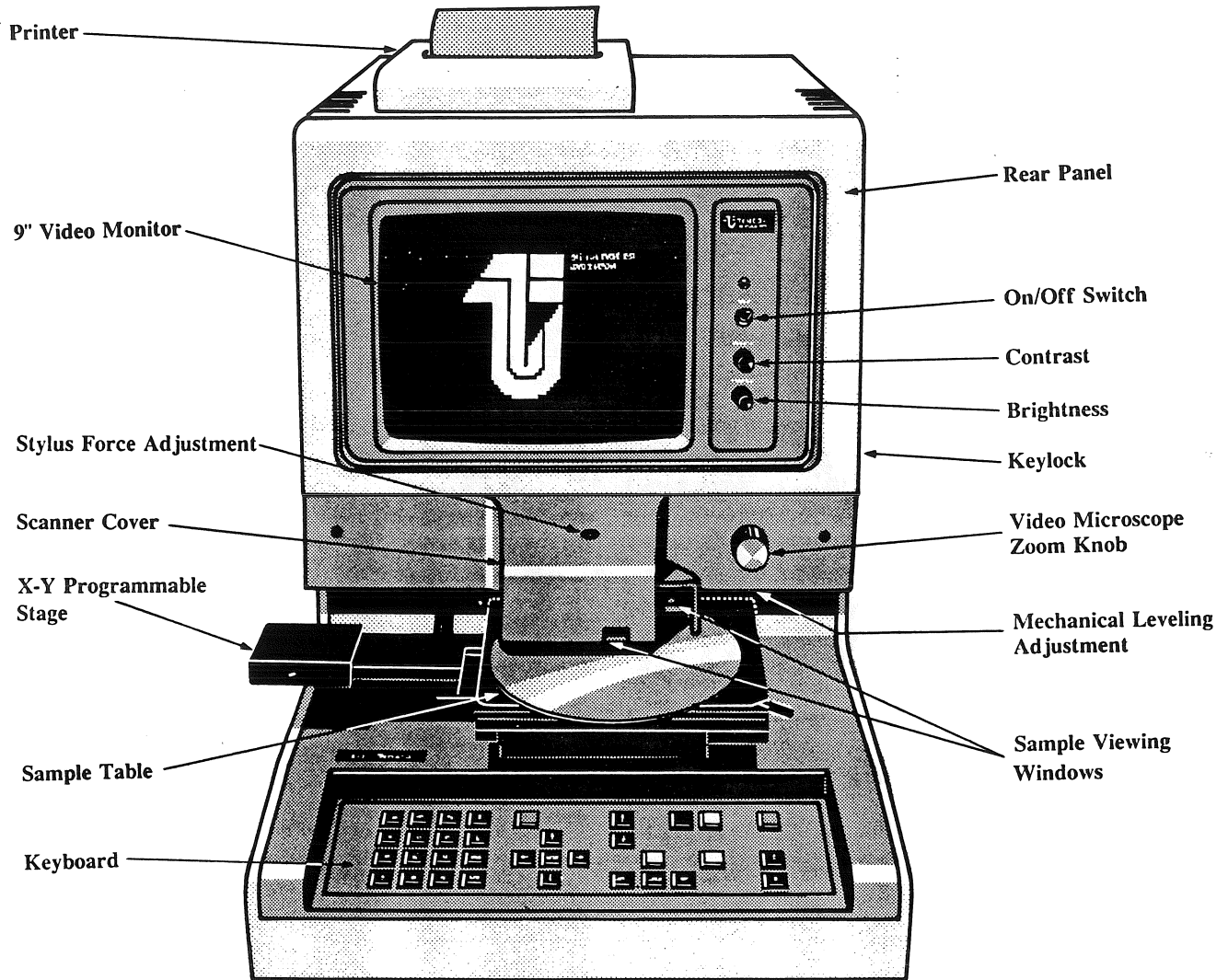

Figure 2: The Alpha-Step 200 (X-Y Programmable Stage Configuration)



# SECTION 1 -- INTRODUCTION

## 1.1 DESCRIPTION

The Alpha-Step 200 incorporates the latest innovations in profiling technology, high magnification image displays and digital data handling for profiling both thin and thick films. It may be equipped with a hood to isolate the sample and scanning mechanism from mechanical or thermal disturbances, thus providing routine measurements of step heights less than 200Å. The Alpha-Step 200 can identify discontinuities in the tens of Ångstroms.

The Alpha-Step 200 CPU automatically controls leveling and measurement. The monitor displays both the actual scan, via the high-power video microscope, and the graphic charts of the scan profile.

By pressing a single button, operators can initiate a preprogrammed sequence that raises the sample stage, lowers the stylus, starts the scan, and displays the auto-leveled and auto-scaled profile on the CRT.

The scan length and stylus force (which is continuously monitored and displayed) can also be adjusted easily. The instrument's dynamic range is from 5Å to 3,200 KÅ.

## MEASUREMENT CAPABILITIES

The instrument samples up to 2000 data points on each scan, providing up to one sample every 400Å with the possible selection of real-time digital filtering.

As many as 2,000 data points are stored in the computer for subsequent analysis. The operator can use movable cursors, controlled from the keyboard, to expand profile details and to make horizontal or vertical measurements. These measurements are constantly displayed on the CRT, representing the current position of the cursors. A different set of cursors may also be used to specify new zero points for re-leveling.

Measurements are made by positioning the cursor lines to intersect the profile. The vertical and horizontal distances between the intersections are highlighted. Average Height, TIR, Ra (Roughness) and Cross-Sectional Area values are instantly recalculated and displayed whenever the cursors are repositioned.

The Scan Menu displays the measurement parameters used for the scan. Scan length and sampling density (samples per micron) are highlighted, scan direction is displayed and the time required to perform the scan is computed automatically. The leveling end points are also displayed. All of these parameters can be changed at any time with a few simple keystrokes.

The cursors may be moved independently or in tandem, to any other points on the display. Areas of interest can be magnified. By repositioning the cursors and pressing the plot button, the magnified profile instantly appears on the screen. Rescaling of the graph and leveling of the new plot is automatic. The cursors can be repositioned for additional measurements or remagnification.

The Alpha-Step 200 accurately measures surface profiles below 200 Å and up to 160 microns, making it suitable for a variety of applications. The software has been designed to minimize measurement error due to operator interpretation, while maintaining the flexibility required for detailed scientific analysis. The calibration standards are traceable to NBS, and allow verification of measurement integrity.

## **SOFT FILMS**

Measurement of soft films, such as softbaked photoresist, can be made with stylus forces below 5 mg, minimizing the possibility of damage. The stylus force is continuously monitored and can be easily adjusted without removal of the housing.

## UNEVEN SURFACES

When measuring rough or uneven surfaces, cursor positioning becomes critical to measurement accuracy. For example, the surface of thick films or magnetic disc coatings can deviate hundreds of Angstroms. The Alpha-Step 200 has two software features which alleviate this problem. The Average Height of the profile relative to the referenced baseline is automatically calculated. For even more measurement accuracy, the Delta Average feature can be used. In this mode, the Alpha-Step 200 automatically calculates the average height of one region relative to the average height of another region. The two regions are well delineated and can be of different lengths.

## MULTIPLE MEASUREMENTS

To minimize the effects of spurious environmental noise on measurement accuracy, the Alpha-Step 200 can automatically calculate the average value of multiple measurements. This feature is especially useful for measuring submicron geometries, rough-surfaces, or for critical calibration.

## VERY SMALL GEOMETRIES

The Alpha-Step 200 has many features and options specifically designed for measuring very small geometries. The high magnification zoom optics (90x to 270x) provide a sharp video image which facilitates precise stylus positioning before measurement. With the programmable x-y stage, substrate features can be automatically located for measurement. Submicron styli are designed specifically for measuring submicron geometries. To ensure accuracy, up to 2000 data points are taken in a single scan, as often as one data point every 400 A.

## SURFACE QUALITY

To measure surface textures, the Alpha-Step 200 automatically calculates and continuously displays Average Roughness. Surfaces of both deposited films and a variety of substrate materials (including silicon, ceramic and metals) can be monitored.

## COMPONENTS

### PRINTER

Provides hardcopy output of the entire screen (including profile) or the Summary Data only. Data may also be sent to the RS-232C output.

### 9" VIDEO MONITOR

Shows the scan menu, summary data and profile, or video microscope display.

### SCANNER COVER

Protects assembly. Must be removed to change the stylus.

### X- AND Y-ADJUSTMENTS (MANUAL CONFIGURATION)

Rear knob moves the sample table left to right (X), front knob moves it from front to back (Y).

### SAMPLE TABLE (MANUAL CONFIGURATION)

Accommodates samples up to 162 mm (6.4 inches) across. Rotary stage provides 360 degrees of rotation.

### KEYBOARD

Allows operator to change scan parameters and manipulate measurement data.

### SAMPLE VIEWING WINDOWS

Provides view of stylus and sample to supplement Video Microscope display.

### MECHANICAL LEVELING ADJUSTMENT

Used for coarse leveling.(located behind front panel).

### VIDEO MICROSCOPE ZOOM KNOB

Adjusts magnification from 40x to 120x (standard) to 90-270x High Magnification or 12-35x Low Magnification.

### **CONTRAST AND BRIGHTNESS CONTROLS**

Adjusts video display.

### **ON/OFF SWITCH**

Controls main power, does not affect calendar/clock or scan menus.

### **REAR PANEL**

Contains power and interface connections.

## Data Display

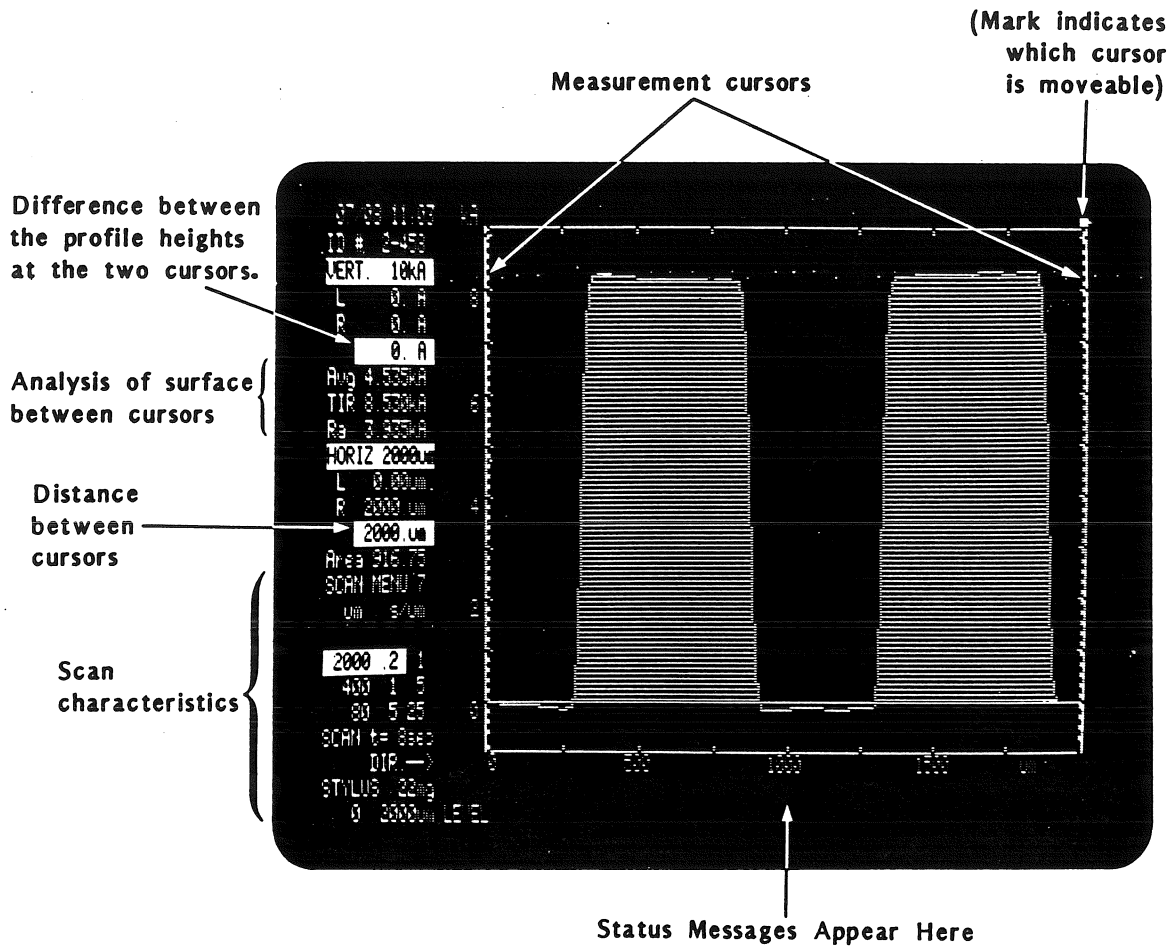

Figure 3: The Alpha-Link Data Display

A scan results in a screen such as the one shown above. In addition to the normally displayed data and profile, the photo depicts one of the surface-analysis features: the shading used to indicate the area under the step.

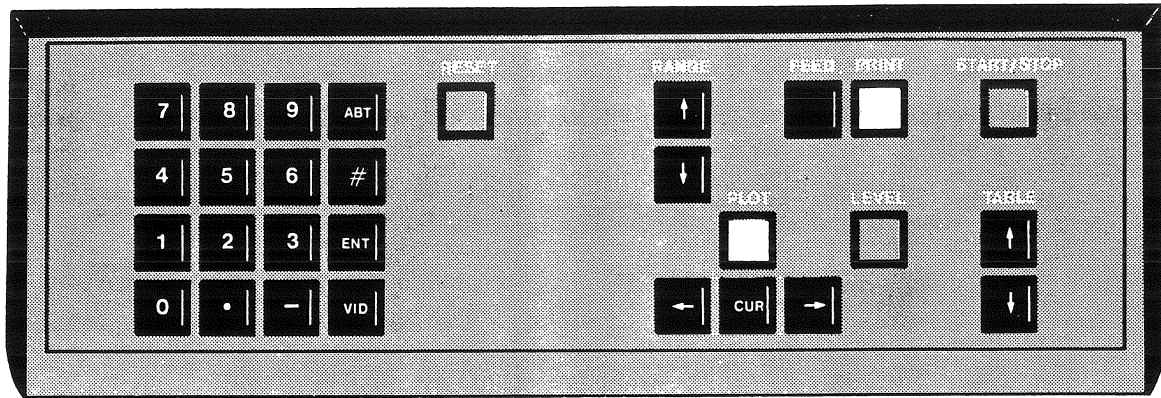

Figure 4: The Alpha-Step 200 Keyboard

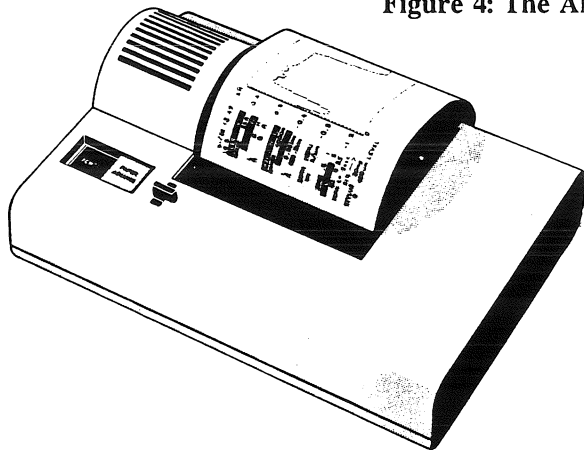
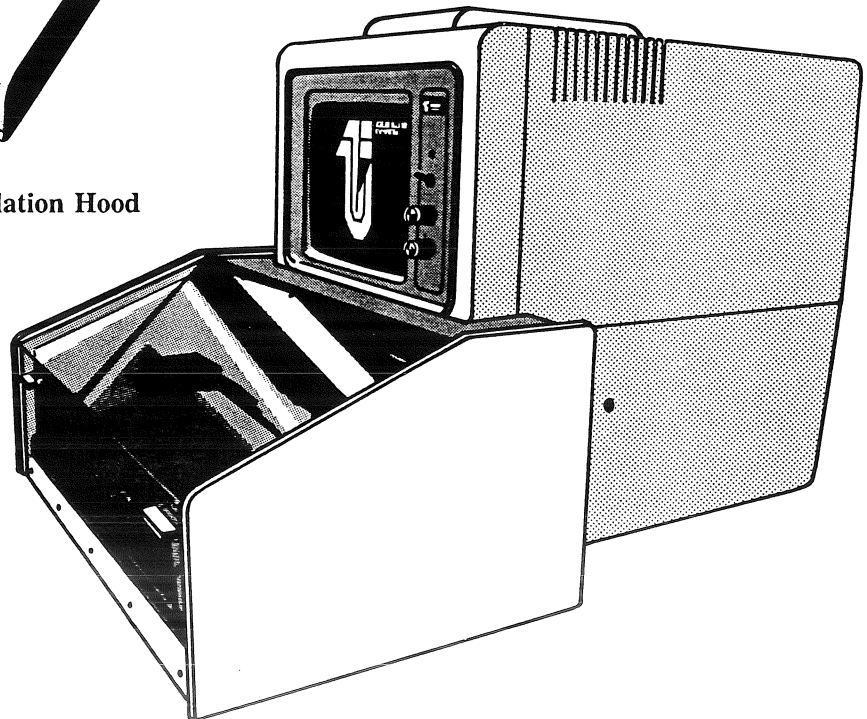

Figure 5: The Alpha-Step 200 Isolation Hood



## 1.2 SPECIFICATIONS

Specifications related to the Programmable X-Y Stage option are contained within that section.

### VERTICAL RANGES

kiloÅngstrom range --  $\pm 160$  kiloÅngstroms  
micrometer range --  $\pm 160$  micrometers

### HORIZONTAL RANGES

Maximum Scan Length ( $\mu\text{m}$ )	Samples per micrometer		Direction
	8-sec	40-sec scan	
10,000		0.2	right only
2,000	0.2	1.0	left/right
400	1.0	5.0	left/right
80	5.0	25.0	left/right

Shorter scans via keyboard entry.  
10,000  $\mu\text{m}$  in micrometer mode only.

### RESOLUTION

VERTICAL -- 5 Å (kiloÅngstrom Range)  
5 nm (micrometer Range)

HORIZONTAL -- 400 Å

### STYLUS

Standard -- 12.5 micrometer radius.  
Optional -- submicron, 1.5 -- 2.5 micrometer, or 5 micrometer, or 25 micrometer.



### STYLUS TRACKING FORCE

User-adjustable 1 to 25 mg, continuously displayed on CRT.  
Forces above 25 mg may also be set.

### MAXIMUM SAMPLE DIMENSIONS

Thickness (with rotary stage) - 16.5 mm (0.65 in.)  
(without rotary stage) 21 mm (0.83 in.)  
Diameter -- Measures to center of 162 mm (6.4 in.) sample.

### SAMPLE STAGE MOVEMENT

X-axis Adjustment - 150 mm (5.90 in.)  
Y-axis Adjustment - 81 mm (3.2 in.)  
Z-axis adjustment - 21 mm (0.83 in.)  
Sample Rotation - 360 degrees

### SCAN METHOD

Moving Stylus (sample remains stationary).

### SAMPLE LEVELING

Automatically computed after scan.  
Manual coarse leveling for bowed or wedge-shaped samples.

### DISPLAY

High-contrast, 9-inch CRT.  
Shows measurement data or 40x-to120x (standard video microscope).

### OUTPUT

Video NTSC Composite image of video microscope.  
Data Internal printer for summary data and plot of profile, and RS-232C serial data output.

**PRINTER**

Standard                      Internal, thermal. Prints entire screen, data  
and plot, in 18 seconds.

**DIMENSIONS**

Width                      330 mm (13 in.)  
Height                     427 mm (16.8 inches)  
Depth                      684 mm (26.9 inches)  
Weight                     26.5 kg (58.8 lbs.)

**VOLTAGE**

90-130 V, 50/60 Hz  
180-260 V, 50/60 Hz

## SECTION 2 -- INSTALLATION

### 2.1 STANDARD CONFIGURATION

#### UNPACKING

- ① Carefully remove the Alpha-Step 200 from its shipping crate. Lift it out by the large strap that surrounds the entire unit. Do not lift it by the sample stage, front cover or printer opening.
- ② Check the packing material for small parts that are packed separately: the rotary stage, the power cord, and any accessories ordered with the instrument (printer paper, calibration standards, extra styli, etc.).
- ③ Inspect all parts for damage. The shipper is responsible for any damage incurred during shipping. If damage is found contact the shipper immediately.
- ④ Slide the back of the unit about 5" off the table and remove large stainless steel lock-down screw with large phillips screwdriver. Then rotate unit around so you can access the stainless steel lock-down screws about 8" in from front and 3" in from right and left edges.
- ⑤ Remove tape from knobs.
- ⑥ **Save the shipping crate, the strap used for lifting the unit from the crate, the lock-down screws, and the protective plastic wrapper.** These items will be needed if the instrument must be reshipped or if a claim is filed with the shipper. If the Alpha-Step 200 is returned to Tencor Instruments for repair, it must be packed in the same shipping crate. A charge will be made if a new crate must be supplied.

*note: No lock down screws are on 1984 model*

*S. Colby  
6-12-91*

## OPERATING ENVIRONMENT

The Alpha-Step 200 has internal shock/isolator mounts to allow many standard measurements to be made in a production line area. For more sensitive measurements or in extremely noisy areas the performance may be improved through the use of granite blocks or special tables (minimum top surface should be 18"x24".) For best performance, follow these precautions:

### CAUTION



**Avoid sudden temperature changes or large drafts. Do not place the instrument directly below an air conditioning outlet.**

Provide a sturdy, level surface. It must be capable of supporting the instrument's weight and measure at least 33cm (13 inches) wide by 63.5cm (25 inches) deep. To accommodate the isolation hood the surface must be at least 18" wide.

## SET-UP

- Place the instrument in the operating environment described above. If an external computer is to be connected, plug it into the proper rear-panel connector.

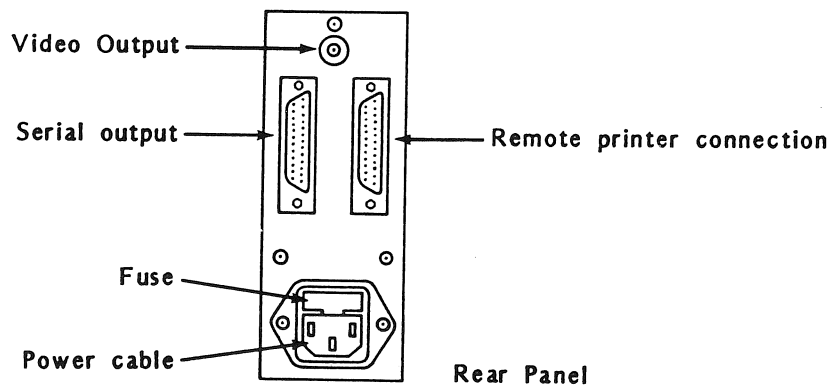

Figure 7: The Alpha-Step 200 Rear Panel

The RS-232C serial output is a DB-25 connector wired as a DCE. It is described in the section "Serial Output Configuration."

- 2 Plug the power cord into any adequate electrical outlet and turn on the power. The sample table should move up and down when **TABLE ↑** and **TABLE ↓** are pressed.

**CAUTION**

Do not raise the table, **TABLE ↑**, without a substrate directly under the stylus.

- 3 Place a roll of paper in the printer. See the section "Printer Paper Change" for instructions.
- 4 Install the rotary stage: Lower the table all the way down using the **TABLE ↓** key and move the table forward by rotating the Y-Adjustment Knob. Place the spindle on the underside of the rotary stage into the front bushing in the middle of the sample table.

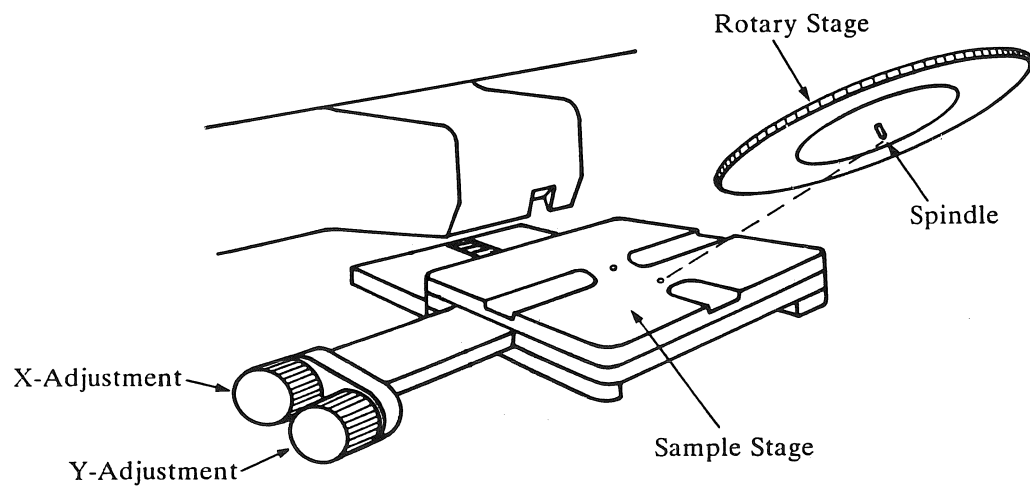

Figure 8: Removing the Rotary Stage

Please perform the sample test (described in the tutorial section) to become familiar with the instrument and to check the installation.

## 2.2 X-Y PROGRAMMABLE OPTION

### CONNECTIONS

After unpacking the instrument, connect the power cord to the back of the case (see figures below) and a 0.125" inner diameter vacuum line to the quick-connect coupling. If the vacuum chuck requires installation, read "Vacuum Chuck" below.

### VACUUM CHUCK

#### CAUTION



Before removing or installing the vacuum chuck, lower the table all the way using the **TABLE ↓** key and move the stage to HOME position by pressing **0**.

To remove the vacuum chuck, rotate the chuck to the 180-degree position and lift straight up.

To install the vacuum chuck, center the chuck pins over the precision hole of the sample stage and gently drop straight down.

## SECTION 3 -- TUTORIAL

Before discussing the Alpha-Step 200 in detail, it is useful to scan a sample and thus gain some familiarity with the instrument. A calibration standard can be used for this scan. If the power is still on from the set-up procedures, the instrument should be ready for operation. If not, turn on the power and allow 10 minutes warm-up time while reading this tutorial. To make a measurement, follow these steps:

### 3.1 LOADING THE SAMPLE

- 1 Press **TABLE ↓** (located on the right-hand side of the keyboard). Hold the button to lower the sample table until there is at least 1/8-inch of clearance beneath the scanner cover and the top of the sample.
- 2 The Y-Adjustment Knob is located on the front left side of the sample table. Rotate it forward to move the table forward.

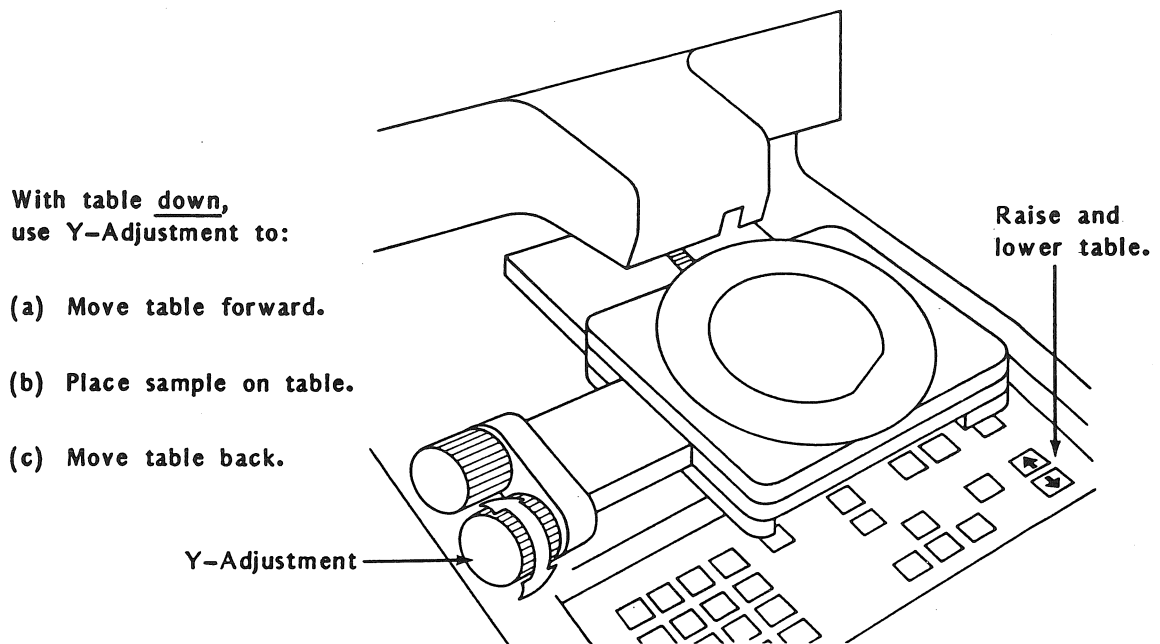

**Figure 9: Loading the Sample**

- Place the sample on the table in front of the scanner cover. Use proper handling techniques to avoid scratching or contaminating the sample.
- Rotate the Y-Adjustment Knob back to move the sample under the scanner cover and locate the step beneath the stylus.

Do not raise the stage, **TABLE ↑**, unless there is a flat substrate under the stylus assembly.

Watch the sample and stylus as you move the table back to make sure the sample will not hit the stylus.



- 3 Press and hold **TABLE ↑**.

The sample table will rise until the sample surface contacts the stylus and moves into the instrument's operating region. It will then stop automatically.

When the table is fully raised, **TABLE ↑** is used to toggle the stylus between its retracted position and its lowered position.

### 3.2 VIEWING AND POSITIONING THE SAMPLE

The Video Microscope image is displayed on the screen when the table is raised. The stylus appears as a dark wedge at the top of the screen. The surface to be measured can be seen beneath the stylus.

Adjust the brightness and the contrast controls for the best picture. The Video Microscope Zoom Knob controls the magnification.

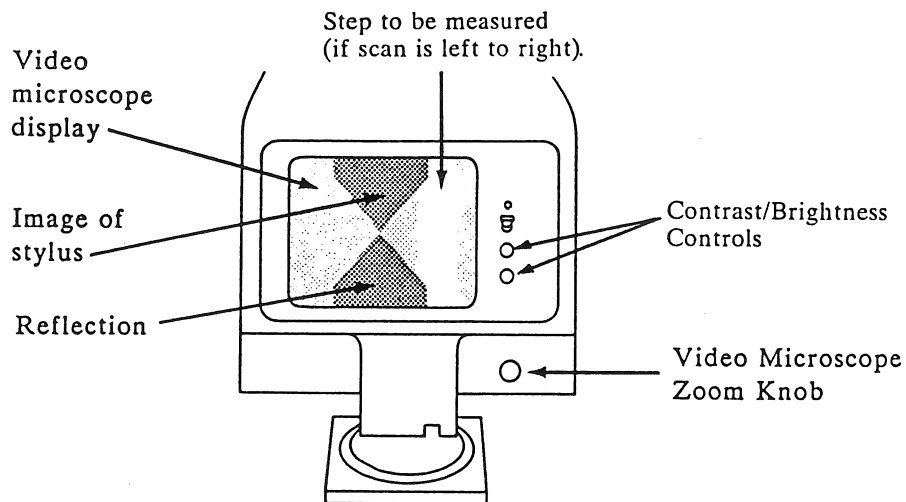

Figure 10: Viewing the Measurement

- ① Use the X- and Y-Adjustment Knobs to position the sample. If the scan direction is from left to right, place the feature to be examined to the right of the stylus tip.

The scan direction is indicated in the scan menu with the abbreviation DIR. Press **ENT** to see the scan menu. Use **→** and **←** (located next to **CUR**) to change direction if desired.

**CAUTION**

Keep the stylus retracted while moving the sample. Lower it only when making short, careful moves to find the scan's exact starting point.

### 3.3 THE SCAN

The scan menu shows the current settings of such parameters as scan length, scan direction, and the number of samples per micrometer. The section "Setting Scan Parameters" describes the techniques for changing these parameters. This should be done **BEFORE** the scan is initiated. For the sake of this tutorial it will be assumed they are already set correctly and need not be changed. (This is often the case in production-line work).

- ① Press the green **START-STOP** key to initiate the scan. The stylus will scan across the sample. When the scan is complete, the sample table will lower to allow the sample to be removed. The stylus will retract into the scanner cover and return to its starting point.

### 3.4 READING AND PRINTING THE DATA

Data collected during the scan are retained in the instrument's memory until one of the following actions is taken: the power is turned off, **START STOP** is pressed to initiate another scan, or **RESET** is pressed. The next steps allow the data to be examined, but will not destroy it.

The screen will show a plot of the surface profile. The display automatically adjusts the ranges to provide the maximum magnification without profile feature spilling off of the screen. (It will not autorange below 1  $\mu\text{m}$  full scale immediately after a scan.)

**NOTE**

The profile is automatically leveled before being plotted. The instrument recomputes the data, placing each end of the scan at the same height. If one end of the scan is raised up on a feature and the other is not, the profile will appear tilted.

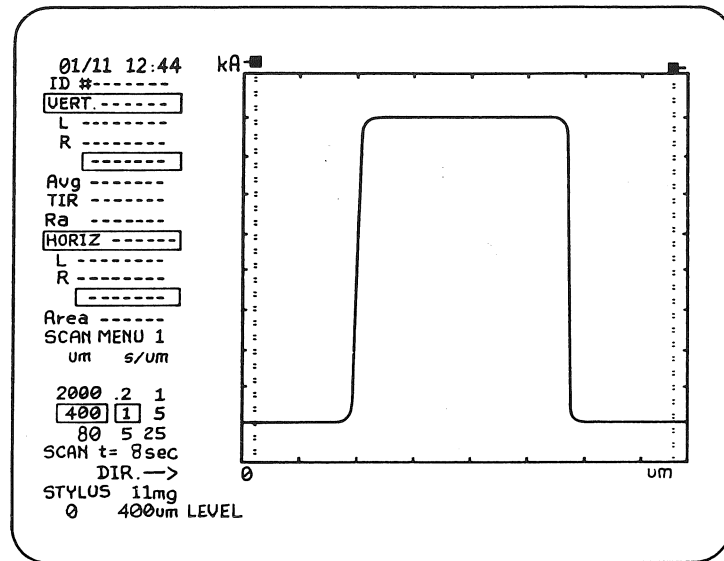

Figure 11: A Surface Profile Plot

The Alpha-Step 200 can easily correct for this without rescanning, as described in the section "Leveling a Completed Scan." For purposes of this tutorial, it will be good practice to try another scan.

A summary of all scan data is displayed to the left of the profile. The scan parameters are shown beneath the label "SCAN MENU." In general, the screen shows the parameters which will affect the NEXT scan. However, the parameters from the last scan remain on the screen until they are changed. The measurement data appears above the scan menu, labeled "VERT" and "HORIZ." When the measurement cursors are positioned properly, horizontal and vertical measurements can be read directly from the data summary. The next steps demonstrate the method of moving the cursors.

- ① **[CUR]** selects which cursor can be moved. The cursor at the right edge of the screen is movable after a scan. Pressing **[CUR]** twice activates the left cursor. (Pressing **[CUR]** once will allow both cursors to be moved simultaneously.) A flag at the top of the cursor(s) indicates which cursor(s) can be moved.
- ② The **[←]** and **[→]** keys move the cursor(s) selected in the previous step. Position one cursor at the base of a step and one cursor on top of the step.

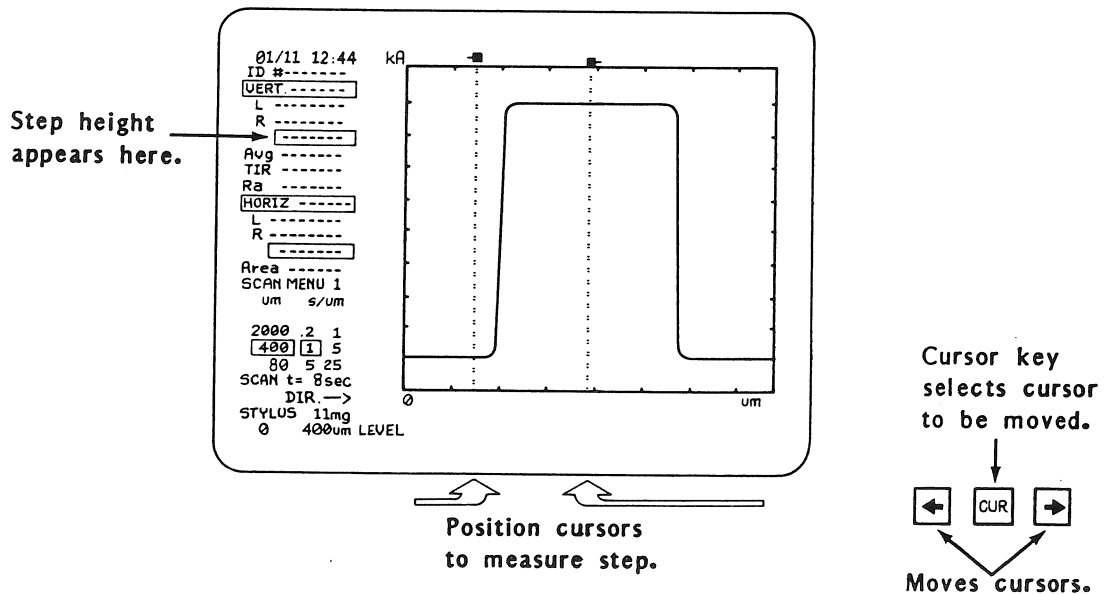

Figure 12: Positioning Cursors to Measure Step Height

\* Even if they have been changed, the parameters from the last scan will be displayed during a print-out or data send.

The values of these parameters are shown in the scan menu, in the lower left of the screen. Nine different Scan Menus may be saved -- each with its own scan parameters. Changes in the scan menu will affect the next scan, and all subsequent scans, until further changes are made. Changes in the scan menu do not affect data still displayed from the previous scan nor do they affect print-outs made from this data. The scan menu currently displayed on the screen can be changed using the procedures described in the next sections.

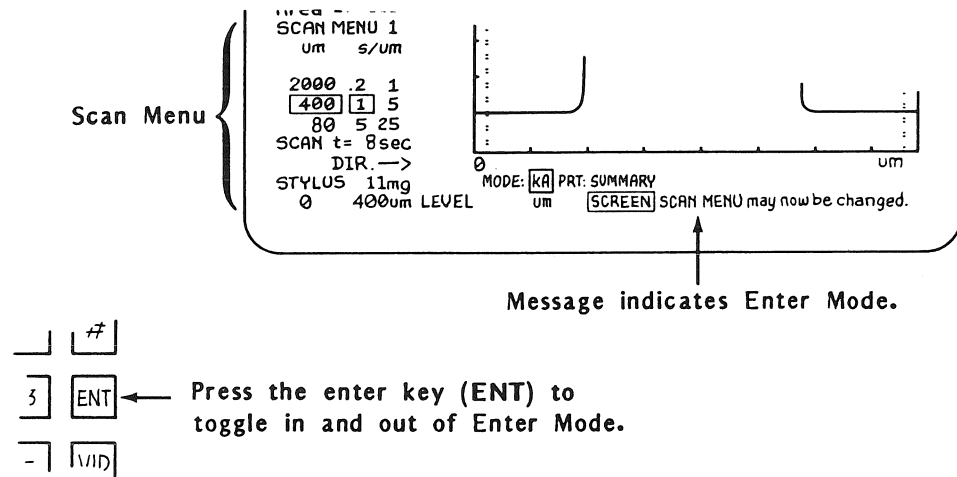

Figure 14: Changing the Scan Menu

**[ENT]** must be pressed before changing the parameters listed in the scan menu. This will invoke the Enter Mode. The message:

SCAN MENU may now be changed

will be displayed at the bottom of the screen. All of the scan parameters can be changed as long as this message is displayed. Their setting will be accepted when Enter Mode is terminated by one of two actions: pressing **[ENT]** again to toggle out of the scan menu or pressing **[START STOP]** to initiate a scan.

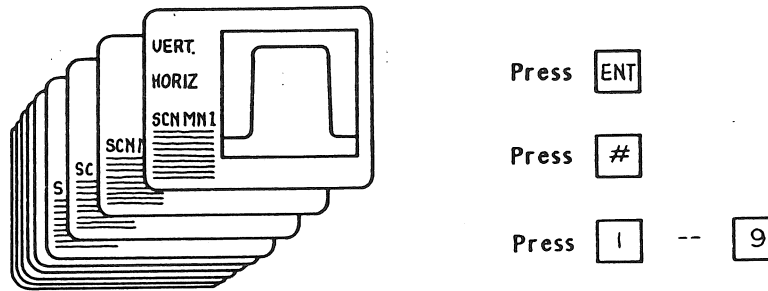

Figure 15: Selecting a Stored Scan Menu

To select a particular scan menu:

- 1 Press **ENT** to display the message

SCAN MENU may now be changed

- 2 Press **#**.
- 3 Press the desired scan menu number, (one through nine).

The scan menu selected will be displayed. Its parameters can be changed using the procedures in the next sections.

Any changes in these parameters will be stored when the Enter Mode is terminated by pressing **ENT** or **START STOP**.

To enter the default settings into the currently selected scan menu: Press **ENT** if not in Enter Mode, then press **ABT**. The defaults are 400  $\mu\text{m}$  scan length, 1 sample/ $\mu\text{m}$ , left to right direction, leveling cursors at the ends of the scan, and vertical units of  $\text{k}\text{\AA}$ .

- ④ To return to the scan menu used for the previous scan: Press **ENT** if not in Enter Mode, then press **#**, then **ABT**.

## SCAN LENGTH AND SAMPLING DENSITY

The highlighted areas in the scan menu show the scan length and the number of samples per micrometer. The time required for the scan is computed and displayed. Notice that all but the 10,000  $\mu\text{m}$  scan have a choice of sampling densities. (The 10,000  $\mu\text{m}$  scan length is only available when scanning from left to right, with the vertical units in micrometers.) Using more samples per micrometer offers higher resolution but requires more time for a given scan length. To change these parameters to the desired values:

- ① Press **ENT** to display  
SCAN MENU may now be changed
- ② Use **RANGE↑** and **RANGE↓** to choose the desired scan length and sampling density. The highlighted scan length/sampling rate combination will change as the range keys are pressed.

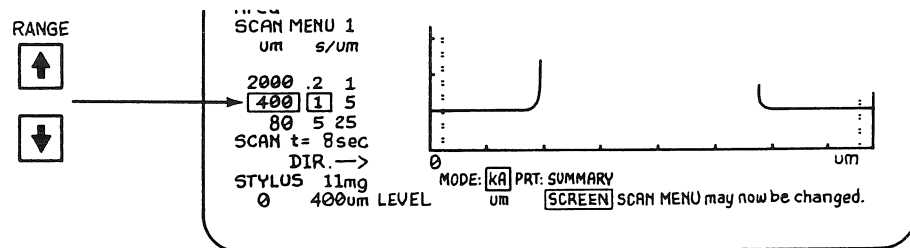

Figure 16: Changing the Scan Length and Sampling Rate

- ③ For scans shorter than the lengths listed: Use the numeric keypad to type in the scan length in micrometers. A scan length less than the default values may be selected.

If the scan length is changed by pressing the range keys, the entry will be lost.



The profile height at each cursor is indicated in the data summary under the label "VERT." The difference in heights is the highlighted number shown beneath it. The horizontal positions of the cursors, and the difference between them, are shown beneath the label "HORIZ." The other fields are discussed in later sections of this manual. With the cursors positioned properly, measurements can be read directly from the fields on the screen.

- ③ Position the cursors around a step, press the yellow **PLOT** key. The display will "zoom" in on the profile feature bracketed by the cursors to show an expanded portion of the scan. This allows detailed inspection of any part of the profile. To return to the original plot of the entire scan; press the abort key labeled **ABT**.

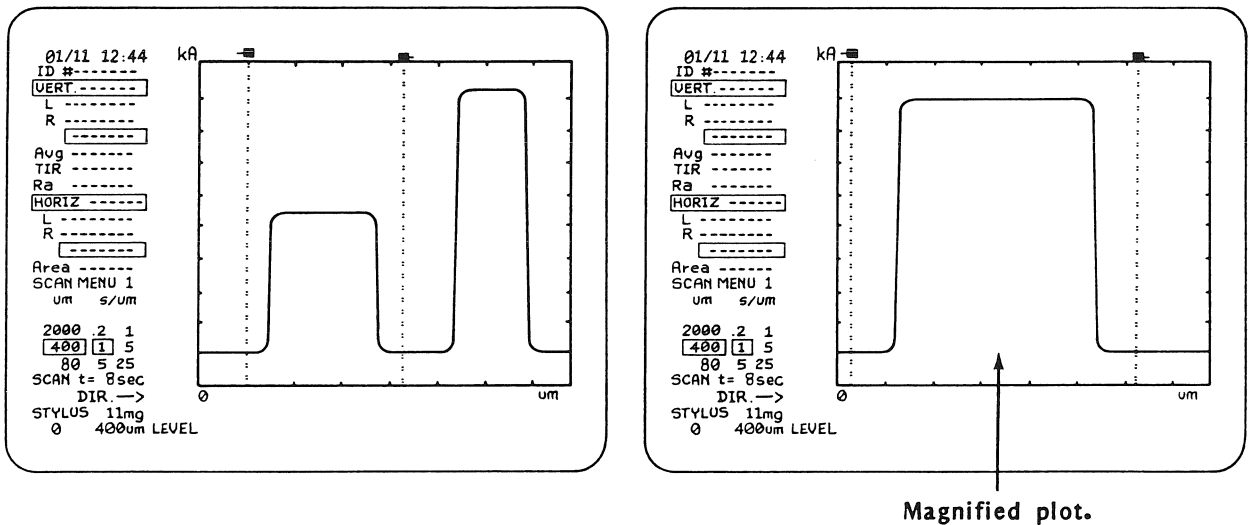

Position cursors.

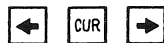

Press



Figure 13: Positioning Cursors to Magnify Scan Features

- ④ To print the screen or data summary, press the white **PRINT** key. An ID Number may be entered before printing to identify the scan, as described in the section "Entering ID Number."

## SECTION 4 -- OPERATION

### 4.1 SETTING THE SCAN PARAMETERS

Scan parameters such as the scan length and direction must be determined **before** the scan is initiated. They do not have to be set before every scan -- they will remain in effect for all scans until they are changed again. The Alpha-Step 200 stores the values of the scan parameters even if the power is shut off or **RESET** is pressed.

The scan menu number is shown on the screen next to the label **SCAN MENU**. Nine different scan menus may be stored, each containing values for the following scan parameters:

- Scan length
- Samples per micrometer
- Scan direction
- Vertical Units
- Leveling cursor positions.

- ④ There is no need to terminate the entry with a special keystroke. It will be accepted when Enter Mode is terminated by pressing **[ENT]** again, or when a scan is started by pressing **[START STOP]**.

## SCAN DIRECTION

The scan direction is shown at the bottom of the scan menu with the abbreviation "DIR" and an arrow pointing in the direction of stylus travel. To change the direction:

- ① If the message

SCAN MENU may now be changed

is not displayed, press **[ENT]** and it will appear.

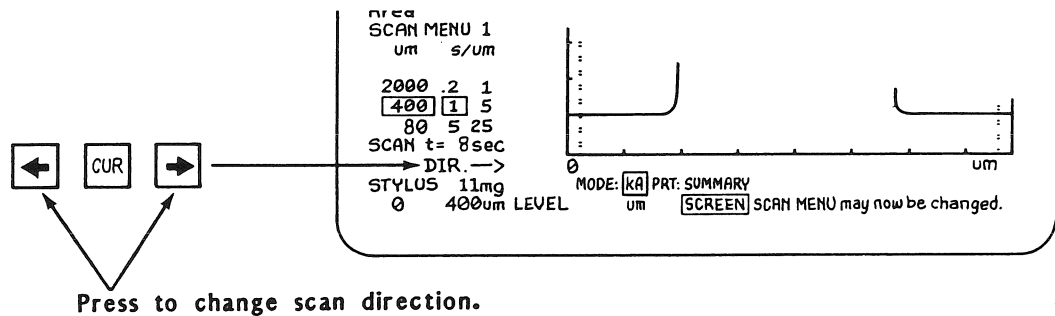

Figure 17: Changing the Scan Direction

- ② Choose the direction by pressing either **[←]** or **[→]**, located by **[CUR]**. The scan menu will indicate the direction chosen. The entry can be changed as long as the message

SCAN MENU may now be changed

is displayed.

- ③ The entry will be accepted when Enter Mode is terminated. (If the direction has been changed, there will be a brief delay while the instrument resets its mechanism.)

## VERTICAL UNITS (kÅ OR $\mu$ M MODE)

Changing this parameter will affect all height measurements beginning with the next scan taken. It will not affect data still on the screen from the previous scan (or a print-out of this data).

Measurements can be made in either of two modes:

kiloÅngstroms --  $\pm 160$  kiloÅngstroms full scale  
5 Ångstroms resolution

micrometers --  $\pm 160$  micrometers full scale  
5 nanometers resolution

While in Enter Mode, the choice of vertical units is shown at the bottom of the screen, labeled **MODE**. The highlighted field indicates the units in use.

The screen shows both vertical units and vertical range. (Units are shown at the top of the vertical axis; range is shown next to the label VERT) There is a distinction between the two. The choice of vertical units affects the gathering of data. It determines the resolution, the maximum full scale reading and the units in which the data will be displayed. The vertical range only affects the display of the profile. When the profile is plotted, the instrument automatically chooses the range for the highest magnification the profile will allow. This is discussed in later sections.

### NOTE



**CHOOSE EITHER THE kÅ OR  $\mu$ m MODE. SWITCHING FROM kÅ TO  $\mu$ m DECREASES ACCURACY DUE TO A ROUND OFF ERROR.**

To change the vertical units, follow the steps listed below:

- 1 Press **ENT** to display

SCAN MENU may now be changed

- 2 Press **CUR** to change the vertical units. The units chosen will be highlighted at the bottom of the screen next to the label **MODE**.

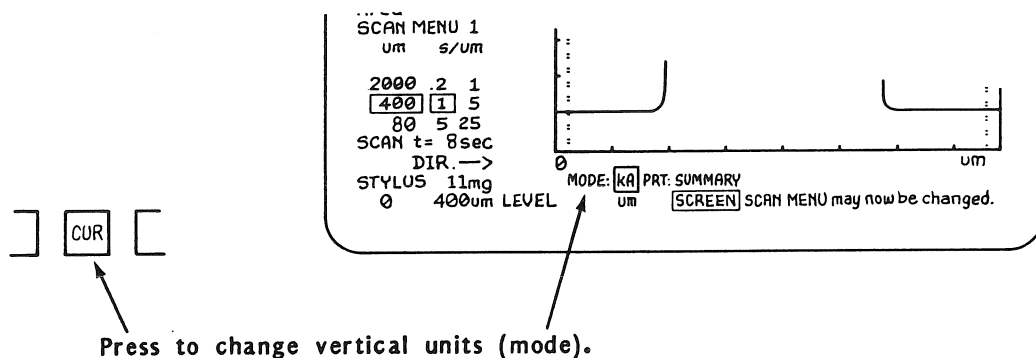

Figure 18: Changing the Vertical Units

- 3 The selection will be accepted when Enter Mode is terminated by pressing **ENT**, or when a new scan is initiated by pressing **START STOP**.

## 4.2 THE SCAN

### POSITIONING THE SAMPLE

Before measurement, the sample must be placed on the sample stage beneath the scanner cover and positioned so the feature of interest is next to the stylus. The Alpha-Step 200 simplifies these critical tasks, allowing precise operation with minimum danger to the sample and the instrument.

If the sample is not positioned so that the scan will begin and end at the same level, the display will appear tilted. This can be easily corrected without having to rescan, as described in the section "Leveling a Completed Scan."

### CONTROLLING THE SAMPLE TABLE

Use **TABLE ↑** and **TABLE ↓** (located at the far right of the keyboard) to raise and lower the sample table.

#### CAUTION



Do not press **TABLE ↑** without a substrate on the sample table.

To load a sample:

- ① Press **TABLE ↓** if the table must be lowered to accommodate the sample. This will not be necessary if the last sample tested was of the same thickness.
- ② Use the Y-Adjustment Knob, located on the left side of the table toward the front, to move the table completely forward.

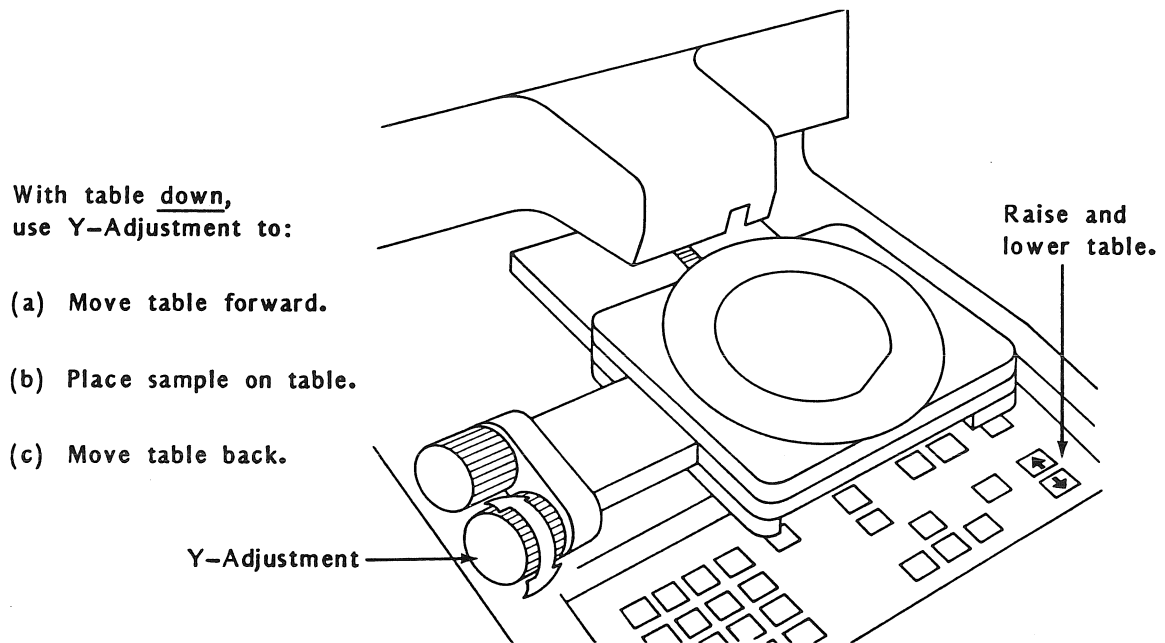

Figure 19: Controlling Motion of the Stage

- ③ Place the sample on the table in front of the scanner cover. Use proper handling techniques to avoid scratching or contaminating the sample.
- ④ Turn the Y-Adjustment knob to move the table back until the sample is under the scanner cover. Watch the stylus through the windows.

- ⑤ With the sample under the stylus, press and hold **TABLE ↑** to raise the table. The table will stop when the sample's surface is in the instrument's operating region.

When the sample table is fully raised, **TABLE ↑** will no longer issue an up command. Instead, repeated pressing will toggle the stylus between its fully retracted position and its lowered position.

**Retract the stylus when moving the sample.**

## VIEWING THE SAMPLE

The Alpha-Step 200 provides two different displays of the sample's surface: the video microscope image and the digitally plotted profile. Pressing **VID** will change between the video microscope display and the data display.

The video microscope is used to aid in positioning the sample; the plot is used to examine and measure the profile. The point on the surface directly beneath the stylus will always be the first point sampled.

The video microscope display will appear on the screen when the sample table is raised. It will remain until the scan is complete. The brightness and contrast knobs are located to the right of the screen.

The zoom knob (located to the right of the scanner cover) controls the video magnification. Turning it clockwise increases the magnification to zoom in on the sample. Turning it counterclockwise decreases the magnification.

The sample may be viewed through the windows on the front and the right side of the scanner cover. Note the reversed image in the mirror on the right.



## MOVING THE SAMPLE

The X- and Y-Adjustment Knobs are located on the left side of the sample table. Use these knobs to position the sample.

**Always raise the stylus when making long moves.**

The recommended procedure for locating the feature to be measured is as follows:

- ① Locate the general area of measurement by looking through the stylus viewing windows.
- ② Using the lower magnification (Zoom Knob rotated counterclockwise) home in on the area of measurement.
- ③ Increase the magnification to center the feature on the CRT.
- ④ Press **TABLE ↑** to lower the stylus for fine positioning.

Position the feature to be measured next to the stylus. Locate it to the right of the stylus if the scan is to be from left to right. Locate it to the left of the stylus if the scan is to be from right to left.

## INITIATING THE SCAN

With the sample in position and the desired scan menu parameters displayed, press **START STOP** to begin the scan.\* The sample table will automatically rise if it is not already in the up position. If the table is lowered too far, it will stop and **START STOP** must be pressed again. The stylus will first make a short pass away from the section of the profile to be scanned. It will then reverse direction so it is traveling in the direction specified in the scan menu. Data collection will begin when the stylus passes the point where it was positioned prior to starting the scan. When the scan is complete, the stylus will automatically retract and the table will lower so the sample can be removed.

---

\* The isolation hood is recommended for acoustic and thermal isolation when making very precise measurements. See Ordering Information for details about obtaining this accessory.

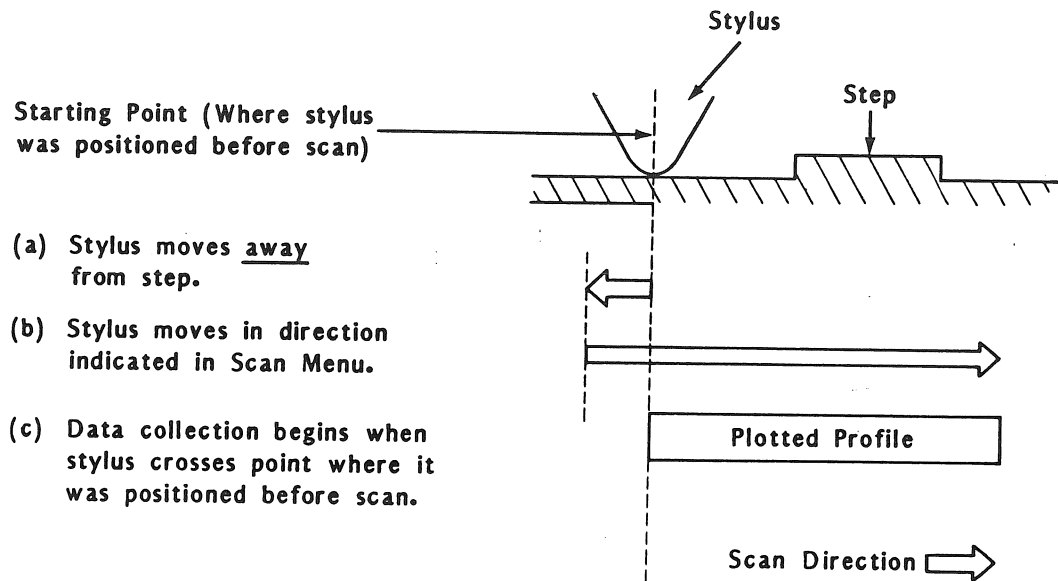

Figure 20: Stylus Motion During Measurement

- To end the scan before reaching the scan length indicated in the scan menu: press **START STOP**. This does not affect the data -- the scanned region will still be displayed in the usual manner.
- Initiating a scan terminates all modes and enters any parameter changes that were made (including changes to the scan menu, the ID Number, and the leveling cursor positions).

## 4.3 DATA

The Alpha-Step 200 digitizes measurement data and stores it in memory during the scan. After the scan, the profile is plotted on the screen with a summary of the data displayed next to it. For many applications, this initial display will contain all of the necessary data. When further analysis is required, it can be performed in the instrument's computer, without having to rescan. The next sections describe the techniques for interpreting the data.

### MEASURING PROFILE FEATURES

Both horizontal and vertical measurements are made simultaneously, using the two measurement cursors. These cursors are vertical lines, drawn with dashes, which can be positioned on the feature to be measured. Cursor-derived measurement data is continuously displayed in the data summary on the left side of the screen.

Vertical measurements are shown in the data summary under the heading "VERT." The highlighted value displayed next to the heading "VERT" is the vertical full scale plot. The profile heights at the left and right cursors appear directly beneath the label. The difference between the heights is calculated and shown in the highlighted area below the cursor heights.

To measure the height of a step:

- ① Position one cursor so that it intersects the substrate at the base of the step.
- ② Position the other cursor so that it intersects the profile on top of the step. The vertical difference is the step height.

The highlighted value displayed next to the heading "HORIZ" is the horizontal full scale of the plot.

The horizontal position of each cursor is shown under the heading and the distance between them is highlighted. To measure the width of a feature: Position one cursor on each side of it and read the horizontal distance between the cursors from the data summary.

The other fields in the Summary Data provide a further analysis of the profile between the cursors. This is discussed in the section titled "Surface Analysis."

**NOTE**

If the profile appears tilted, consult the section "Leveling a Completed Scan" to correct the leveling before making measurements.

## CURSOR POSITIONING

The cursor key, (labeled **[CUR]**), selects the cursors for movement. The movable cursor is indicated by a small mark above it (see figure next page). After each scan, the right cursor is movable. Pressing **[CUR]** once makes both cursors movable. Pressing **[CUR]** twice makes the left cursor movable. (When both cursors are moved simultaneously, they will stay a constant distance apart.)

The cursors are moved by pressing **[←]** or **[→]** (located on either side of **[CUR]**). When **[←]** or **[→]** is pressed, one or both cursors will move in the direction of the arrow. Cursors automatically speed up when the arrow key is held down for long moves.

- Once positioned, the cursors will retain their positions for subsequent scans. If a batch of similar samples is to be tested, the cursor can be left in position and the measurement can be read directly from the data summary with minimum operator intervention.

The measurement cursors (and the average-reference cursors, described in the section "Average Difference Mode") obey the following rules:

The cursors will stay where they were positioned at the start of the scan with these exceptions:

- If **[RESET]** is pressed prior to starting the scan, the cursors return to where they were positioned for the previous scan.
- If the scan menu is in any way different from the one used for the previous scan, the cursors will move to the ends of the scan.\*
- A scan can be terminated before it reaches its pre-set length without affecting the cursors. However, if the scan is too short to accommodate the right cursor, it will be positioned at the end of the scan. If the scan is too short to accommodate the left cursor, it will be placed at the beginning of the scan. When the next complete scan is made, the cursors will return to where they were positioned prior to the terminated scan.
- The cursors can be returned to the ends of the scan by pressing **[CUR]** then **[ABT]**. The original (the plot displayed immediately after the scan) will be displayed.

---

\* When **[START\_STOP]** is pressed, the instrument checks to see if the scan menu is different from the one used for the previous scan. Therefore, it is possible to alter the scan menu and then return to its previous setting before pressing **[START\_STOP]** without affecting the cursor positions.

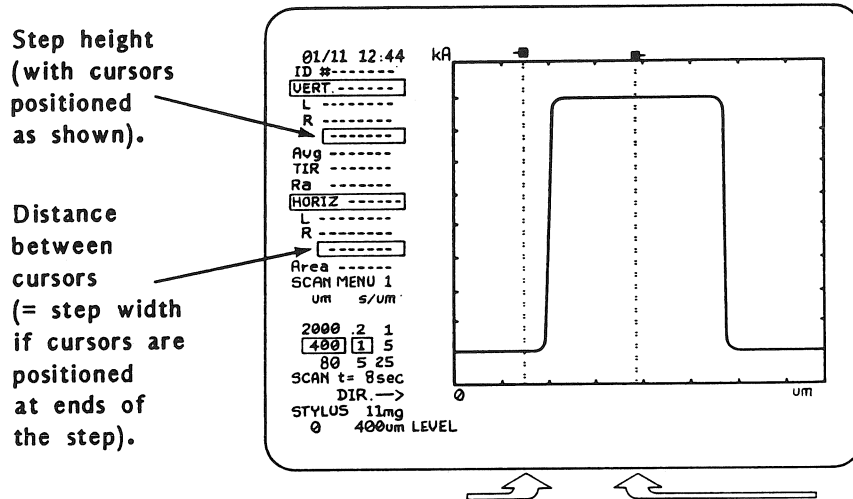

Figure 21: Positioning the Cursors to Measure Step Height

## PLOTTING INDIVIDUAL PROFILE FEATURES

Any portion of the profile can be magnified for close examination. Using the procedure explained in the previous section, position the cursors so they bracket the feature of interest, then press the yellow **PLOT** button. The display will zoom in on the bracketed region. Both the horizontal and vertical scales will autorange to provide the greatest magnification of the bracketed feature. A list of the horizontal and vertical ranges available is presented in the section "Range Selection."

The horizontal and vertical ranges are displayed in the data summary at the left side of the screen. The axes are labeled accordingly. Notice the axes are labeled relative to the scan's starting point. This means that their zero points may not appear on the screen after zooming.

Ranges Before Zoom

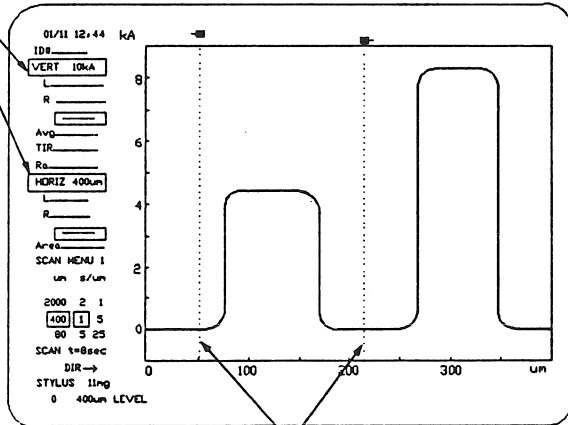

Cursor positioned at step.

Ranges After Zoom

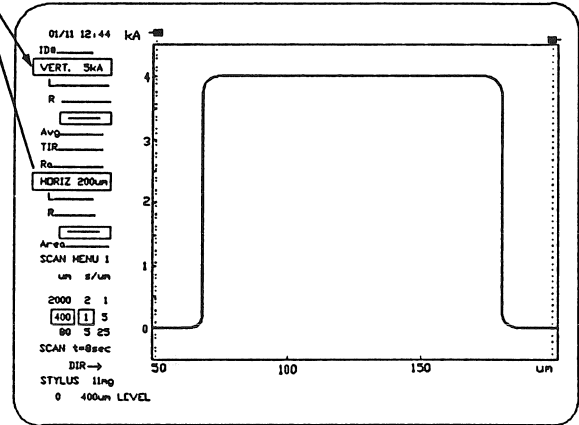

Plot magnified to show step.

Press PLOT  
to zoom.

Figure 22: Magnifying a Step Feature for Greater Clarity

The cursors will still be located at the same points on the profile after the image is replotted. The profile will be positioned to place the left cursor at the left edge of the screen. The right cursor will appear in the right half of the screen after the zoom.

- To return to the previous magnification before zooming (to undo a zoom): Press **[PLOT]** again without moving the cursors. The cursors will remain in their most recent positions. Pressing **[PLOT]** more times will not cause zooming until a cursor has been moved.
- To return to the screen showing the entire profile (displayed immediately after the scan): Press **[ABT]**. This undoes all zooming, but it leaves the cursors at their most recent positions on the profile.
- Pressing **[CUR]** then **[ABT]** will undo all zooming and return the cursors to the end points of the scan.

## OVERRIDING VERTICAL AUTORANGE

Press **[RANGE ↑]** or **[RANGE ↓]** to change the vertical range of the display. The range is indicated in the data summary, next to the label "VERT." When the desired range is selected, press **[PLOT]** to redraw the image. The profile will be centered vertically where it intersects the left cursor. Some of the profile may spill off of the screen at higher magnifications.

- Press **[ABT]** to return to the original trace.



## VERTICAL CENTERING

The procedures described above can be used to reposition the plot on the screen. When plotted, the intersection of the left cursor and the profile will be vertically centered at the left edge of the plot and the right cursor will be in the right half of the screen. Therefore, to reposition the plot:

- ① Place the left cursor so that it intersects the profile in the desired position.
- ② Press **RANGE ↑** or **RANGE ↓**
- ③ Press **PLOT**
- ④ Press **ABT** to return to the original trace.

## ENTERING ID NUMBERS

If the measurements are to be saved by printing, it is useful to assign an ID Number for identification at a later time. The number can be up to eight characters long. It can be any combination of numeric keys – numbers, decimal points, or dashes. To enter an ID Number follow the steps listed below.

**NOTE**

This procedure cannot be performed in Enter Mode. If the message  
SCAN MENU may now be changed  
is displayed, press **ENT** to terminate Enter Mode.

- ① Press **#**. The message  
ID NUMBER may now be changed  
will appear on the screen.
  - If it does not appear, the instrument is likely still in Enter Mode.
- ② Type in the number.
  - To abort an entry and return to the previous ID Number, press **ABT**.
- ③ To terminate the entry, press **ENT**, or press **PRINT** to make a print-out, or press **START STOP** to take a scan.

To clear the field without making a new entry, simply press **#** and then **ENT**.

## PRINTING OR SENDING DATA

The Alpha-Step 200 offers a choice of three printing modes. They determine what will happen when **PRINT** is pressed. The modes are:

- Screen
- Summary Data
- Data Send

### SCREEN

The entire contents of the screen, including the plot of the profile, will be printed.

### SUMMARY DATA

Only the data shown on the left side of the screen will be printed. The profile will not be printed.

### DATA SEND

Data will be sent to the RS-232C serial output instead of the printer.

Screen and Summary Data print modes are used to make print-outs on the internal printer or on the optional remote printer. Data Send uses the RS-232C serial output to send the data to an external device such as a host computer.

If the RS-232C output has not been configured for the output device, see the section "Serial Output Configuration " before using Data Send Mode.

The choice of printing modes is made in Enter Mode. The chosen print mode will remain in effect until changed, even if the power is turned off or a different scan menu is selected.

To select the print mode:

- 1 Press **ENT** to display

Scan Menu may now be changed

- 2 Press **PRINT** to change the print mode. The selection will be highlighted in reverse video.
- 3 With the desired mode selected, press **ENT** to leave the scan menu, or press **START STOP** to leave the scan menu and begin a scan.

To print (or send) data: Press **PRINT**.

- To abort a print-out (or data send) before it is complete, press **ABT**.

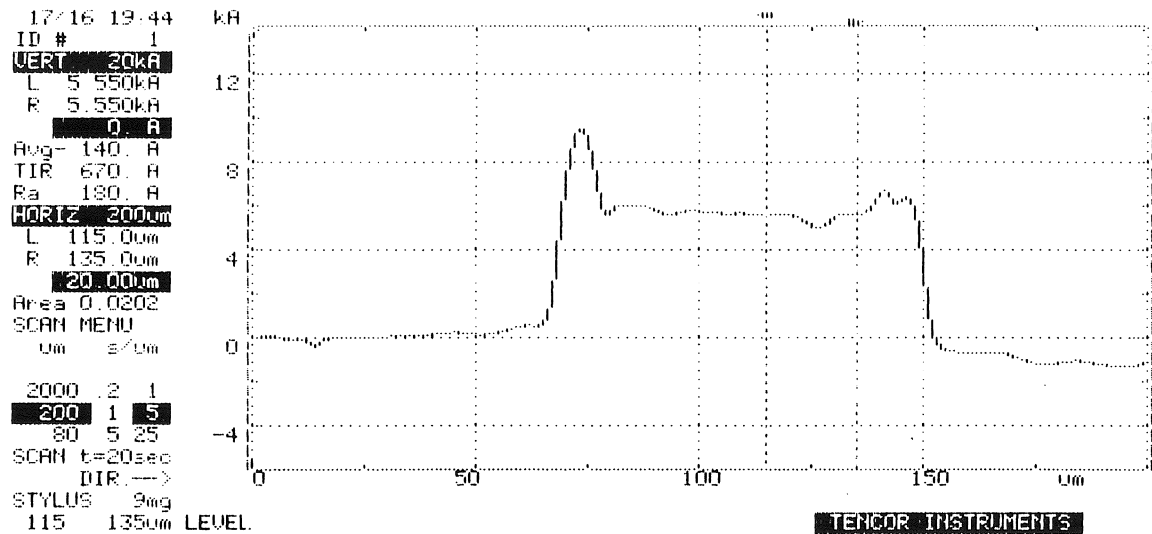

Only this portion is printed if  
Summary Data is selected.

Figure 23: A Printout Made in Screen Mode

A print-out or data send can be initiated whenever the results of a scan are displayed on the screen (unless a special operation is being performed, such as changing the scan menu, leveling a completed scan, or changing the stylus force).

The type of print-out will depend on the current printing mode. It will display the scan menu that was in effect when the scan was taken and, in Screen Mode, the portion of the profile displayed when **PRINT** was pressed.

In Data Send Mode, data will be output as a series of ASCII characters. The summary data is sent first. Fields shown on the screen in reverse video are indicated with asterisks. The profile is sent after the summary data. Only the portion shown on the screen at the time of the data send is included, allowing surface features to be singled out for transmission. The profile is converted to a table of numbers for the purpose of transmission. Each number is a profile height at a point on the screen. Every line in the table begins with a number indicating the horizontal position of the first data point in the line. See "Serial Output Configuration" for more information.

## PROGRAMMED FUNCTIONS

The Alpha-Step 200 provides an analysis of four important surface characteristics. They are displayed in the data summary with the following abbreviations:

### **AVERAGE HEIGHT (AVG)**

Calculation of the average height of all data points between the measurement cursors, referenced from the leveled baseline.

### **TOTAL INDICATED RUNOUT (TIR)**

Calculation of the difference in height between the highest and lowest points within the cursors.

### **AVERAGE ROUGHNESS (RA)**

Calculation of center-line average roughness according to American National Standards Institute Specifications (ANSI B46.1-1978)

## CROSS-SECTIONAL AREA (AREA)

Calculation of the area above the line between the intersections of the measurement cursors and the profile.

Three additional data analysis features are available on command from the keyboard:

### **Repeat and Average**

Reduces relative measurement error by automatically scanning the same location multiple times. The height measurements are averaged together and their average value is displayed on the screen.

### **Slope**

Useful for comparative measurements, the angle of the plotted surface profile is measured in degrees.

### **Delta average**

Provides precise height measurements of rough or uneven substrates and films. This software quantifies the difference between the average height of one region and the average height of another. The two regions can be of differing lengths.

## AVERAGE PROFILE HEIGHT (AVG)

The average height of the profile section between the cursors is displayed with the label "Avg." It is measured relative to a base line established by the intersection of the profiles with the leveling cursors.

To view the base line used in this measurement, press and hold the key labeled with a dot .

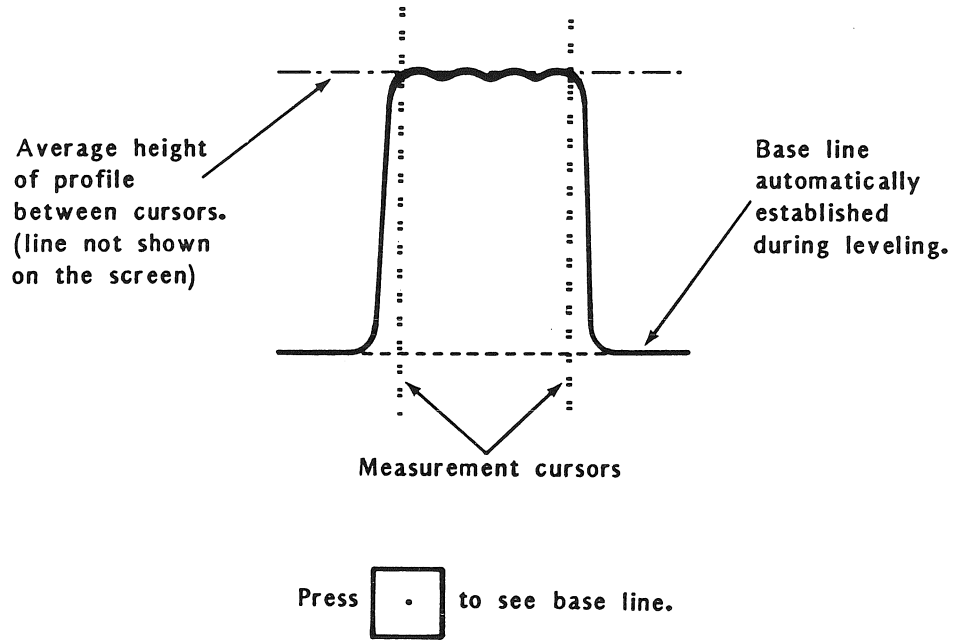

Figure 24: Measuring the Average Profile Height

## TOTAL INDICATED RUNOUT (TIR)

Abbreviated TIR, this measurement is the difference between the maximum and the minimum profile heights. It is computed for the section of the profile between the measurement cursors.

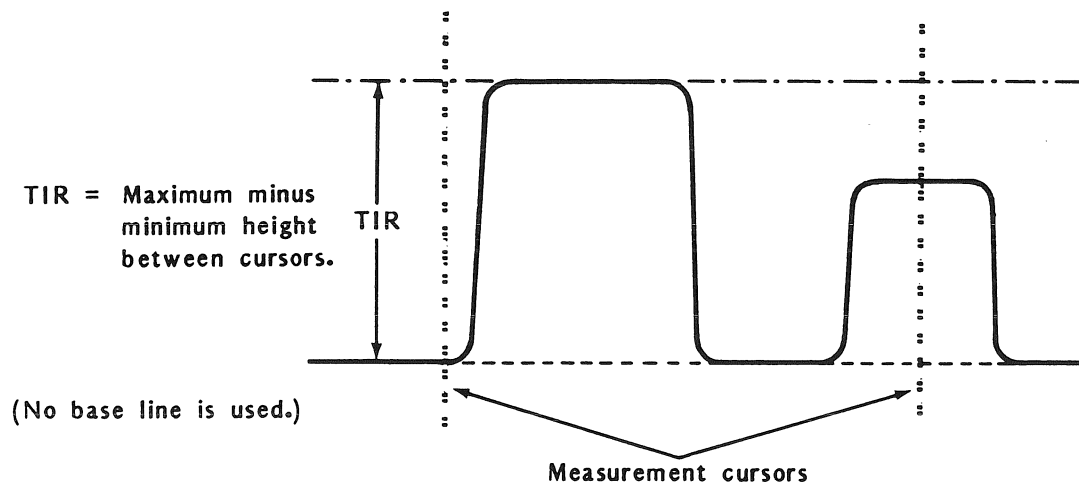

Figure 25: Measuring the Total Indicated Runout (TIR)



## ROUGHNESS (RA)

The arithmetic average surface roughness is determined using the graphical-centerline method. This reading can be used to compute roughness according to the ANSI Standard B46.1-1978. However, for most applications, the value displayed for RA can be used directly, without further computation. The diagram below shows the principle of measurement:

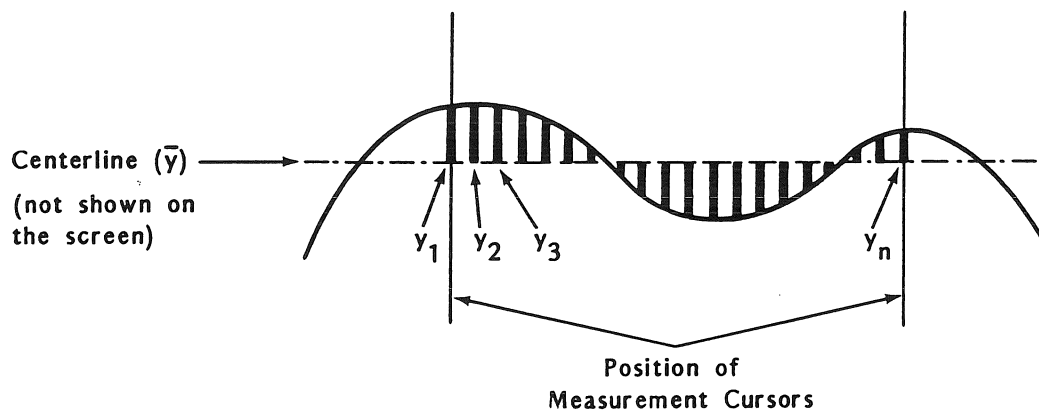

Figure 26: Measuring the Roughness

$$RA = \frac{y_1 + y_2 + y_3 + \dots + Y_n}{n}$$

where:

$y_1$  through  $y_n$  = the absolute value of the difference between the profile height and  $|y|$  for each point between the measurement cursors. (This is the deviation from the centerline.)

$|y|$  = the profile heights at the points between the measurement cursors summed together and divided by  $n$ . (The profile heights are relative to the first point of the scan.)

$n$  = The number of points between the measurement cursors.

## AREA

The cross-sectional area of the profile above a base line is displayed in square micrometers. The base line extends between the intersections of the two measuring cursors and the profile. This line is not necessarily horizontal -- the angle depends on the positioning of the cursors and the profile. Only the parts of the profile above the line are included in the measurement. Any part of the profile that dips below the line will not be counted.

- To see the area included in the measurement:

Press and hold .

The area will appear shaded, as shown.

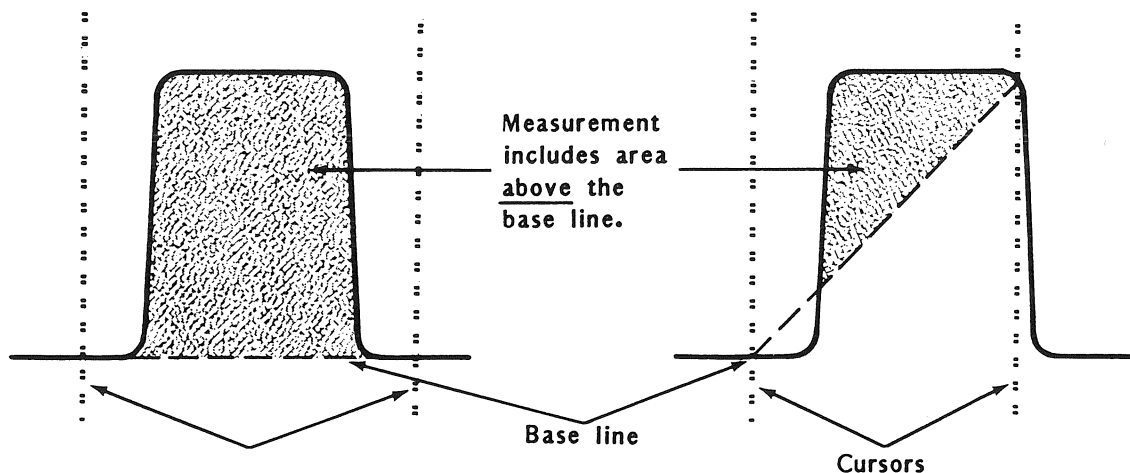

Press  to see base line and area.

Figure 27: Measuring the Area

## AVERAGE DIFFERENCE MODE

In Average Difference Mode, the Alpha-Step 200 computes the difference between average-height measurements. When this mode is entered the currently displayed average is stored as a reference reading. The instrument displays the difference between this reference and all subsequent average-height measurements. This mode remains in effect until it is exited, even if another scan is taken. To use this mode:

- ① Level the plot, if necessary, using the procedure in the section "Leveling a Completed Scan."
- ② Position the measurement cursors on the section of the profile to be stored as the reference reading.
- ③ Press **ENT**, then press the key labeled with a dot **.**

The vertical-height field will be re-labeled "dAv" for average difference. It will read "0" until the cursors are moved.

The reference profile section is marked with vertical lines called the average-reference cursors. These cursors are drawn with large dashes and connected by bars at the top and bottom of the screen to distinguish them from the other cursors.

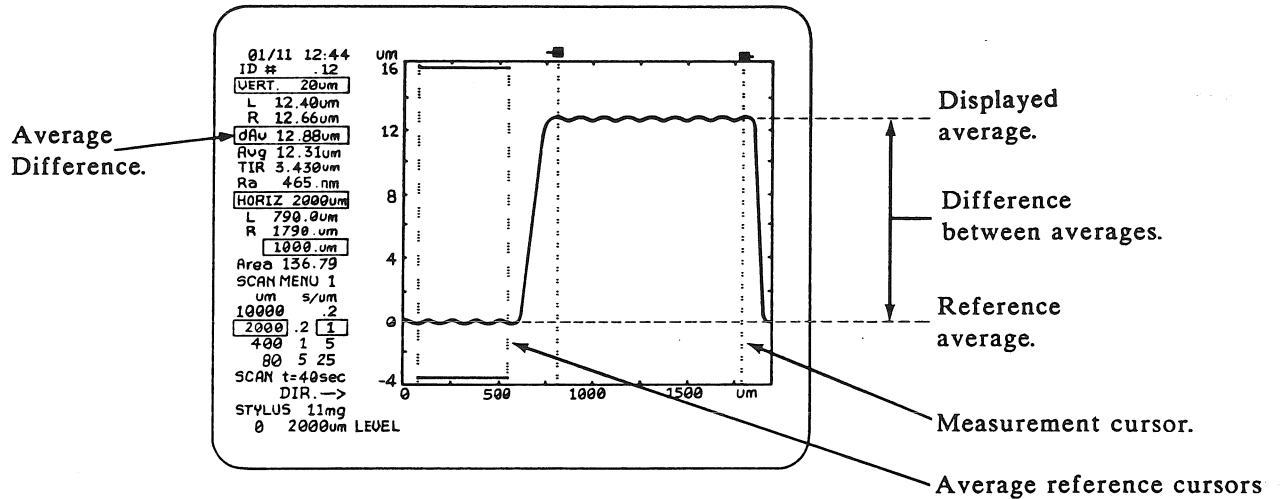

Figure 28: Computing the Average Difference

- ④ Position the measurement cursors on the profile section to be compared to the reference.

The field labeled "Avg" will show the average profile height between the measurement cursors. The field labeled "DaV" will now show the difference between this value and the reference reading. When the measurement cursors are moved, the average height and difference will be updated.

- To zoom in on the profile section between the measurement cursors, press **[PLOT]**. To un-zoom, press **[PLOT]** again without moving the cursors.

To return the plot showing the entire profile, press **[ABT]**.

- ⑤ To exit Average Difference Mode, press **[CUR]** then **[ABT]**. The vertical height field will now display the difference between the measurement cursor heights.
- ⑥ Average Difference Mode will be terminated if the power is turned off or if the scan menu is changed.

## REPETITIVE SCANS IN AVERAGE DIFFERENCE MODE

The instrument will remain in Average Difference Mode when a new scan is taken. The average-reference cursors and the measurement cursors will stay where they were positioned in the previous scan. After the scan, the instrument will calculate the average height of the profile between the reference cursors and use it as a reference until the next scan is taken.

- If the plot requires leveling, pre-set the leveling cursors so repetitive scans can be made without having to level after each scan. See the section "Pre-Positioning the Leveling Cursors" for details.
- A scan can be terminated without exiting Average Difference Mode. If possible, all cursors will remain where they were positioned in the previous scan. However, if the scan is not long enough to accommodate the cursors, the cursors will be moved to their respective ends of the scan (as described in "Cursor Positioning"). When the next complete scan is taken, both sets of cursors will return to where they were prior to the aborted scan.

## 4.4 LEVELING

### LEVELING A COMPLETED SCAN

When the profile is plotted after a scan, a leveling program aligns the trace to the two axes to facilitate accurate measurement. Leveling cursors, vertical lines normally invisible to the user, are used to indicate two points on the profile whose heights are equal. The leveling program recomputes the measurement data to make these heights equal on the display. The rest of the profile is displayed relative to these points.

The leveling cursors are normally located at the ends of the scan. If one cursor is on a surface feature higher or lower than the other cursor, the substrate will appear tilted when the program makes both cursor heights equal.

The condition described above can be corrected by moving the leveling cursors to places on the profile where the heights are equal. Ideally, they should both be on the substrate, near the ends of the scan, although any equally high points may be used.

The procedures for manual leveling are as follows:

- ① If the message

SCAN MENU may now be changed

is displayed, press **ENT** to terminate Enter Mode.

- ② Press the orange **LEVEL** key. The screen will show the leveling cursors, which are dotted vertical lines, instead of the dashed lines used for measurement cursors. The following message will appear at the bottom of the screen:

MANUAL LEVELING may now be changed

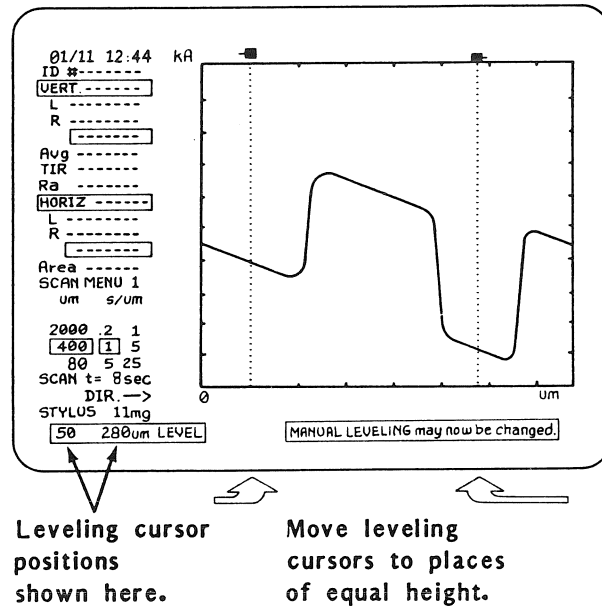

Figure 29: Leveling the Data Display

- ③ Position the cursors so that the actual profile height is the same at each cursor. (Ignore the indicated profile height.) The leveling cursors are moved in the same manner as the measurement cursors, using **←** and **→** in conjunction with the **CUR** key.
- ④ Press the yellow **PLOT** or **ENT** key. The profile will be redrawn with the points under the cursors at equal heights. The horizontal positions of the leveling cursors are shown in the lower left corner of the screen.

The leveling cursors will return to their auto-leveling positions when the next scan is taken.

## PRE-POSITIONING THE LEVELING CURSORS

If several identical samples are to be scanned, it is possible to store the leveling points in the menu. Pre-positioning the leveling cursors allows subsequent scans to be properly leveled automatically. This eliminates the need to manually level after each scan.

The procedures are the same as those described for leveling a completed scan, except that they must be performed in Enter Mode. The message

SCAN MENU may now be changed

must be displayed. When **LEVEL** is pressed, the screen will display the message:

AUTOLEVELING may now be changed

- Changing the scan length will move the leveling cursors back to the ends of the scan.
- A scan can be terminated before it reaches its pre-set length without affecting the leveling. However, if the scan is too short to accommodate the right leveling cursor, it will be positioned at the end of the scan. If the scan is too short to accommodate the left leveling cursor, it will be placed at the beginning of the scan. When the next complete scan is made, the cursors will return to where they were positioned prior to the terminating scan.

The positions of the leveling cursors are shown at the bottom of the scan menu. They will be saved and recalled along with the other parameters in the currently displayed scan menu, allowing nine different pre-set leveling conditions.



## ABORTING COMPUTED LEVELING

Computed leveling can be disabled by positioning the two leveling cursors at the same location. If this is done, the profile will be plotted showing the actual slope present in the data.

A convenient way to abort manual leveling is to press **LEVEL** then **ABT**. The message

Data Not Leveled

will appear at the bottom of the screen.

- The scan menu still displays the positions of the leveling cursors (in the field labeled "LEVEL"). These positions will be used to autolevel the next scan.
- Leveling will be restored the next time **LEVEL** is pressed. (The leveling cursor will return to the ends of the scan.)

It is possible to abort autoleveling. This will affect the data already on the screen and the data from all subsequent scans.

Each of the nine scan menus has its own leveling cursor information. If autoleveling is aborted, this will be saved in the currently displayed scan menu. Whenever this menu is used to control a scan the message

No Autolevel

will be displayed and the plot will not be leveled automatically.

## ABORTING AUTOLEVELING

Press **ENT** if not in Enter Mode; the message

SCAN MENU may now be changed

will be displayed. Press **LEVEL**, then **ABT**. The message **No AUTOLEVEL** will also appear at the bottom of the Scan menus in place of the leveling cursor positions.

## RESTORING AUTOLEVELING

Simply press **LEVEL** while in Enter Mode. If leveling has been previously aborted, the cursors will automatically move to the ends of the scan when **LEVEL** is pressed.

## TECHNICAL LEVELING ADJUSTMENT

Although computed leveling will properly orient the display on the screen, greatest accuracy will be obtained if the sample is physically level with respect to the line of stylus travel. This is especially important when measuring excessively bowed or wedge-shaped samples, which may cause the data to go out of range at the end of the scan.

The mechanical leveling knob may be adjusted while the scan is in progress. This knob is located behind the front cover. It can be accessed by reaching up under the front panel near the zoom knob. To mechanically adjust the leveling, follow these procedures:

- ① Place a flat sample on the sample table.
- ② Press **START STOP**, then press **VID** immediately afterward (or after the scan has begun). The computer plot of the profile will appear as the surface is scanned. A dotted horizontal line is provided for reference.

- ③ If the plot deviates from the horizontal, adjust the mechanical leveling knob. Slowly rotate the knob until the plot is horizontal.

- (a) Start scan.  
 (b) Push **VID** .  
 (c) Reach up under front panel.  
 (d) Rotate knob to affect slope shown on screen.

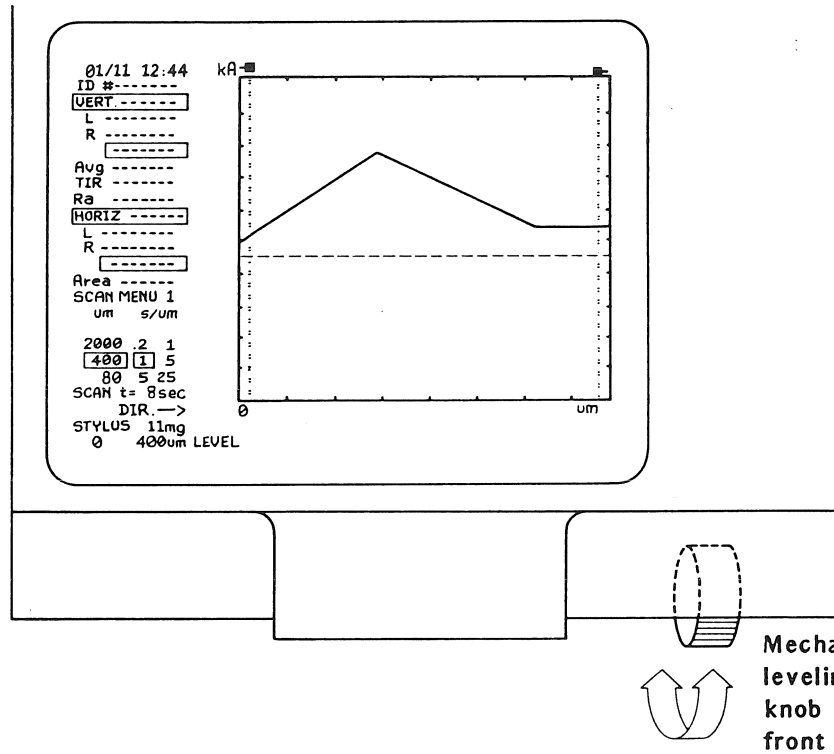

Figure 30: Mechanically Adjusting the Leveling

## 4.5 SOFTWARE FEATURES

### SLOPE MEASUREMENT

The area field serves a dual function: it can be "toggled" from the keyboard to display either the profile area or the slope measurement.

Slope is defined as the rate of rise of a line between two points. For this feature, the line joins two points at the intersection of the measuring cursors and the plotted surface profile. Displayed in degrees, this measurement may be used to compare low-angle slopes of surface features. Slope measurement requires the shortest possible scan with the maximum number of data points: 80 micron scan @ 25 samples/micron.

Before using the slope-measurement feature, a field specifying the slope measurement must be examined (and possibly changed).

Press:

**RESET**  
then **ENT**  
then **VID**

to select the Set-Up Menu. Now press:

**LEVEL**

to toggle filed AREA (Under DISPLAY:) from "AREA" to "ANGLE" ( or vice-versa). Scans taken while this field contains "ANGLE" provide the measured slope instead of the area.

To leave this menu and save the changes, press:

**ENT**

Now a scan can be taken and, if necessary, leveled. After the scan results are displayed, the measuring cursors can be moved to the peak and the foot of the step and the plot expanded (by pressing **PLOT**). The cursors can be repositioned for analysis of any segment of the expanded plot (see Figure below). The measured angle is displayed by field "Angle" of the Summary Data. For more detailed analysis of the change of the slope, lock the cursors close together and move them simultaneously along the profile. Field "Angle" displays the slope of the short segment between the cursors, revealing any change from a straight line as the locked cursors are moved along the slope.

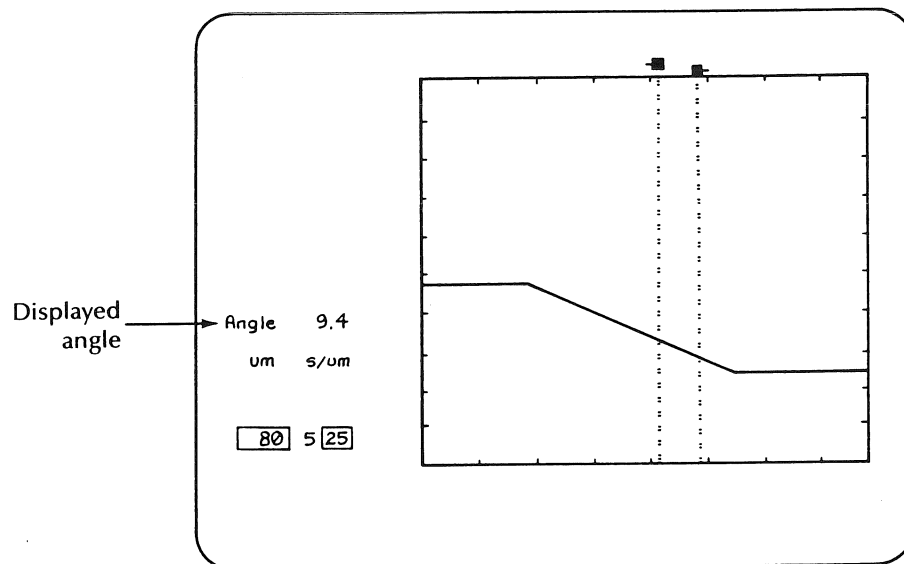

Figure 31: Locking the Cursors and Panning Across the Slope Reveals Detailed slope information

## MULTIPLE SCAN AND AVERAGE

Up to nine consecutive scans can be commanded via the keyboard. The field labeled "Avg" is used to display the average of the Height Differences of the profile at the two measuring cursors, using the measurements from the multiple scans (read "Average Profile Height" for more information about average profile height). While in this mode, the instrument "remembers" the calculated height difference for each scan, adds them together, and divides by the number of scans for the average. Multiple Scan and Average can also be used while in Average Reference Mode.

To use this feature, move the substrate to the desired point of measurement and press:

**ENT**  
**TABLE ↑**

causing the data display to indicate:

REPEAT COUNT (X) may now be changed

where X is the number of scans. To change this repeat count, press the number (2-9) on the keyboard corresponding to the number of scans to be taken and averaged. After setting the repeat count (or leaving the default count) and without pressing any other keys, press:

**START STOP**

to begin multiple scanning.

This feature highlights "Avg" field instead of the Height-Difference Field (see Figure below) in the Summary Data. The results of the final scan are displayed in the Height-Difference Field, while the "Avg" field shows the height difference averaged from the multiple scans.

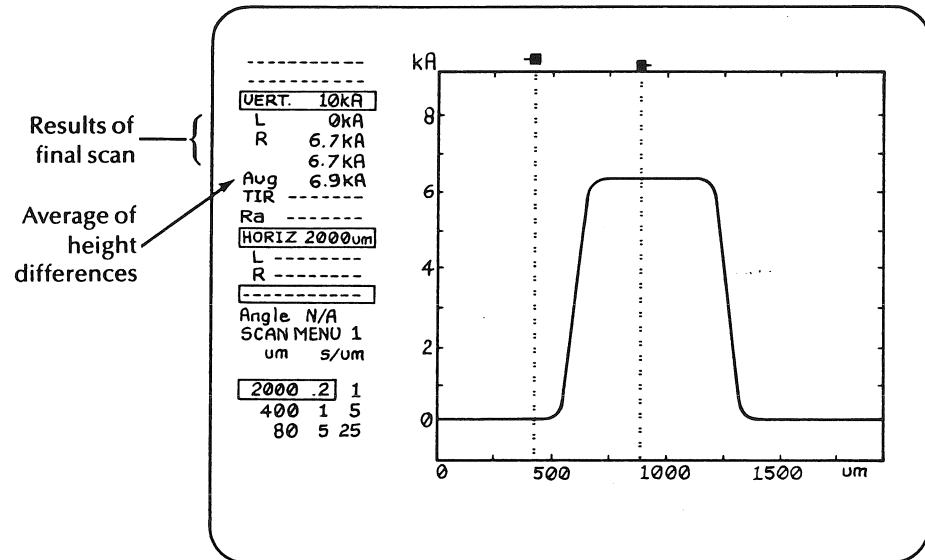

Figure 32: Summary Data Displays the Average Height Difference

## PRINTER CHOICE

*ALPHA (internal) S. Call 10/30/91*

The Alpha-Step 200 uses a ~~Fujitsu printer~~. The printer selection, stored in non-volatile memory, is set at the factory to match the installed printer. However, if the printer does not work, this field should be checked.

Replacement of the printer model requires a hardware modification. This modification should be handled only by Tencor Field Service personnel.

The printer cover used with the Fujitsu printer extends about 1/2" above the top surface. The photograph in section one shows the Alpha-Step 200 equipped with a Fujitsu printer.

To "toggle" between the internal printer and the external parallel output device, press:

**RESET**  
then **ENT**  
then **VID**

which selects the Set-Up Menu. Now display the print parameters by pressing:

**PRINT**

with the print parameters displayed, press:

**PLOT**

To change the output device. When the desired options have been chosen, press **ENT** to save the new values, or press **START STOP** to save the new values and take a scan. To return to the previous values without any changes, press **ABT**.

If the printer stops working, check this printer-selection parameter first -- it may have been accidentally toggled during a change of other print parameters.



## 4.6 SETTING THE REAL-TIME CLOCK

To set the real-time clock, follow the procedure listed below:

① Press **[RESET]**, then **[ENT]**, then **[VID]** to obtain the test set-up menu.

② Press **[C]**. The screen will display the message

Clock may now be set

and the hours field will be ready for change.

③ If the information displayed is correct, press **[ABT]** to leave this procedure. If any field must be changed, the data in all fields must be re-entered, so move the highlighted field to the left-most field by pressing **[←]** two times.

④ Use the numeric keypad to type in the entry. The last two digits typed will be accepted in the field. Press the **[→]** key once to move to the next field.

⑤ Repeat Step 4 until data has been typed in all fields. Leave the highlighted field at the "year" field and go on to ⑥.

⑥ There are two keys to end this procedure at this point:

**[ABT]**: This nullifies the results of ④ and ⑤, leaving the previous value in the real-time clock.

**[ENT]**: This changes the real-time clock to the setting entered by following ④ and ⑤.

Press either **[ABT]** to end without changing the clock or **[ENT]** to end with changes to the clock.

If the minutes were changed, the seconds will be reset to 00. Since the clock begins when **[ENT]** is pressed, set the clock to the next minute and press **[ENT]** to synchronize the Alpha-Step's clock with the reference you are using.

## 4.7 SERIAL OUTPUT CONFIGURATION

The Alpha-Step 200 is equipped to send data from its RS-232C serial output to a device such as a host computer or an 80-column serial printer. Notably, the port is used when communicating with Alpha-Link, Tencor's profiler-to-IBMPC data acquisition interface. The connector, provided on the rear panel, is wired as a DCE. The pinout of the DB-25 connector is as follows:

Pin 1 -- Chassis Ground  
Pin 3 -- Data Out  
Pin 7 -- Signal Ground

The output is designed for "fast" devices such as computers. Slower devices, including some printers, require an internal modification to be performed by Tencor Instruments.

The output can be configured for the particular device receiving the data. The parameters are stored when the power is off, and the configuration procedures need not be repeated once completed.

### TO CHANGE THE SERIAL OUTPUT PARAMETERS

- 1 Press **RESET**, then **ENT**, then **VID** to obtain the test set up menu.
- 2 Press **PRINT**. A list of parameters will appear on the screen, along with their current values. The column on the right, shown in reverse video, indicates which key to press to change each parameter.
- 3 To change a parameter press the key indicated.

Press **RANGE ↑** or **RANGE ↓** to change the Baud rate. Any standard rate from 50 to 38,400 may be chosen. (The default is 1200.)

PRINT —  
SCR Dump  
DATA SEND

MANY Port -

704,664,9251

Press **[#]** to change the number of data bits, the number of stop bits and the parity. (Default is 8 data bits, 1 stop bit, and no parity.) Pressing **[#]** steps through the following list of options:

data bits	stop bits	parity
8	1	none
8	1	even
8	1	odd
7	2	even
7	2	odd
7	1	even
7	1	odd
8	2	none

- Press **[ ]** to change the characters sent at the end of the line: either carriage return and a line feed (CR LF) or a carriage return only (CR) may be sent. (Default is CR LF.)
  - Press the dash **[ - ]** to change the end-of-page indicator: either a form feed (FF) or a row of dashes (---) may be used. (The default is a row of dashes.)
- ④ When the desired options have been chosen, press **[ENT]** to enter the new values for press **[START STOP]** to enter the values and take a scan.
- Press **[ABT]** to return to the previous values with no change.
  - When the printing mode is set to Data Send, pressing **[PRINT]** will send data to the serial output.

Data is sent in a series of ASCII characters. The Summary Data is sent first, indicating the following: the time that the scan was taken, the ID Number, the scan menu in effect during the scan, and the measurement data. Fields shown on the screen in reverse video are indicated with asterisks.

The profile follows the summary data. Only the portion shown on the screen at the time of the data send is included, allowing surface features to be singled out for transmission.

Although the profile is displayed graphically on the screen, it is converted to a table of numbers for the purposes of transmission: The lines in the table are 79 characters long and contain 10 data points, each representing the profile height at a point along the scan. Every line begins with a number indicating the horizontal position of the first data point in the line.

The exact format of the output is shown in the following print-out, a result of a 400-micrometer scan. The leveling cursors were placed at 0 and 130 micrometers, on the top of the step. The measurement cursors were placed at 132 and 174 micrometers, the left cursor on the top of the step and the right cursor at its base. **PLOT** was pressed to zoom in on the 100 micrometers beginning with the left measurement cursor. The print-out shows the data that was on the resulting screen.

```

1234567891012345678920123456789301234567894012345678950123456789601234567897012345678980

10/26 11:37          ID #   0001
VERT.**50kA*         SCAN MENU 1
  L    5. A           um   s/um
  R -22.97kA
    -22.98kA*        2000 .2  1
Avg-11.89kA         **400**1*  5
TIR 22.99kA         80   5 25
Ra 9.445kA
HORIZ**100um       SCAN t= 8sec
  L 132.0um          DIR.-->
  R 174.0um
    *42.00um*        STYLUS 20mg
Area 6.8255         0   130um LEVEL
132.0um:  0.005  0.005  0.010  0.015  0.010  0.000 -0.015 -0.035 -0.070 -0.130
142.0um: -0.260 -0.480 -0.850 -1.415 -2.200 -3.225 -4.470 -5.900 -7.475 -9.155
152.0um: -10.90 -12.69 -14.47 -16.19 -17.80 -19.22 -20.40 -21.32 -21.98 -22.42
162.0um: -22.69 -22.84 -22.91 -22.94 -22.96 -22.96 -22.96 -22.96 -22.96 -22.97
172.0um: -22.97 -22.97 -22.97 -22.98 -22.98 -22.98 -22.98 -22.98 -22.98 -22.98
182.0um: -22.98 -22.97 -22.97 -22.98 -22.97 -22.97 -22.97 -22.97 -22.97 -22.98
192.0um: -22.98 -22.99 -23.00 -23.00 -23.00 -23.00 -22.99 -23.00 -22.99 -22.99
202.0um: -22.99 -22.99 -22.99 -22.99 -22.98 -22.97 -22.97 -22.96 -22.95 -22.94
212.0um: -22.94 -22.94 -22.93 -22.92 -22.91 -22.89 -22.87 -22.83 -22.76 -22.63
222.0um: -22.44 -22.17 -21.84 -21.49 -21.17 -20.93 -20.80 -20.82 -20.96 -21.20
232.0um: -21.48
    
```

```

1234567891012345678920123456789301234567894012345678950123456789601234567897012345678980
    
```

Figure 33: The Serial Output Configuration

**NOTE**



The rows of numbers (0-80) above and below the data are not part of the printout. They are shown here for reference purposes only.

## SOFTWARE VERTICAL CALIBRATION

The Alpha-Step 200's vertical calibration can be adjusted by a factor of  $\pm 5$ -percent from the factory setting using a routine entered at the keyboard.

The vertical calibration software allows the user to enter a "desired reading" that will replace the currently displayed step height. The instrument computes the percentage difference between these values and uses it as a correction factor for all subsequent measurements.

This section tells how to enter the desired reading, and it suggests techniques that help in arriving at an accurate correction factor.

- This procedure requires a sample with a step of a known thickness, such as the calibration standard available from Tencor Instruments.
- The Instrument should be located in a quiet area and the isolation hood should be used to minimize acoustic and thermal effects.

## CALCULATING A CORRECTION FACTOR

- ① Clean the test surface and the stylus with alcohol.
- ② Scan the step and perform the mechanical leveling procedures.
- ③ Locate the step so that its distance from the stylus tip is 1/4 of the diameter of the stylus shank.
- ④ See the scan parameters for a scan of 400 micrometers at 1 sample per micrometer and take a scan.

- ⑤ Pre-set the leveling cursors on the substrate in front of the step so that the next scans will be automatically leveled.
- ⑥ Pre-set the measurement cursors: position one on top of the step and one on the substrate. The cursors should be equally far from the step, at a distance of 50 or 100 micrometers.
  - The displayed step height can be either positive or negative. For maximum accuracy, the step height should be above 2500 Å.
- ⑦ Make seven scans recording the step heights. Discard the highest and lowest readings and compute the mean and standard deviation. The mean is the instrument's "true" reading.
- ⑧ Divide the known step height by the mean to find the correction factor. Multiply the step height currently shown on the screen by the correction factor. Enter this result as the "desired reading" in step 2 of "Entering the Correction."

## ENTERING THE CORRECTION

- ① Press **ENT**, then **PLOT**. At the bottom of the screen the following messages will be displayed:

DESIRED RDG:  
CALIBRATION: 0%  
CALIBRATION may now be changed

- ② Using the numeric keypad, type in the desired reading computed in  
⑧ The entry will appear in the field labeled **DESIRED RDG**.

Correction is limited to a total of  $\pm 5\%$ . If a greater correction is attempted it will be rounded to 5%. If the instrument requires more than  $\pm 5\%$  calibration, contact Tencor Instruments.

- ③ To return to the factor-set calibration, press **ABT**.

To correct an error in typing, press **ABT** and repeat the calibration procedures.

- ④ Press **ENT**. The message "LEVELING now in progress" will be displayed while the instrument makes its internal adjustments. The percentage of change in calibration is displayed at the bottom of the screen during this time.

## CALIBRATING IN AVERAGE DIFFERENCE MODE

The above procedures can be used in Average Difference Mode. In this mode, the reading being corrected is the difference between two averages, one taken on the substrate and one on top of the step. The difference is shown in the field labeled "dAv." The value entered as the desired reading will appear in this field after calibration. Future measurements will be corrected by a factor equal to the ratio of the two readings.

This calibration, like the procedures described above, affects normal measurements as well as those made in Average Difference Mode.



```

1234567891012345678920123456789301234567894012345678950123456789601234567897012345678980

10/26 11:37          ID #   0001
VERT.**50kA*         SCAN MENU 1
  L    5. A           um   s/um
  R -22.97kA
    -22.98kA*        2000 .2 1
Avg-11.89kA         **400**1* 5
TIR 22.99kA         80  5 25
Ra  9.445kA
HORIZ**100um        SCAN t= 8sec
  L 132.0um          DIR.-->
  R 174.0um
    *42.00um*        STYLUS 20mg
Area 6.8255         0 130um LEVEL
132.0um:  0.005  0.005  0.010  0.015  0.010  0.000 -0.015 -0.035 -0.070 -0.130
142.0um: -0.260 -0.480 -0.850 -1.415 -2.200 -3.225 -4.470 -5.900 -7.475 -9.155
152.0um: -10.90 -12.69 -14.47 -16.19 -17.80 -19.22 -20.40 -21.32 -21.98 -22.42
162.0um: -22.69 -22.84 -22.91 -22.94 -22.96 -22.96 -22.96 -22.96 -22.96 -22.97
172.0um: -22.97 -22.97 -22.97 -22.98 -22.98 -22.98 -22.98 -22.98 -22.98 -22.98
182.0um: -22.98 -22.97 -22.97 -22.98 -22.97 -22.97 -22.97 -22.97 -22.97 -22.98
192.0um: -22.98 -22.99 -23.00 -23.00 -23.00 -23.00 -22.99 -23.00 -22.99 -22.99
202.0um: -22.99 -22.99 -22.99 -22.99 -22.98 -22.97 -22.97 -22.96 -22.95 -22.94
212.0um: -22.94 -22.94 -22.93 -22.92 -22.91 -22.89 -22.87 -22.83 -22.76 -22.63
222.0um: -22.44 -22.17 -21.84 -21.49 -21.17 -20.93 -20.80 -20.82 -20.96 -21.20
232.0um: -21.48

```

---

```

1234567891012345678920123456789301234567894012345678950123456789601234567897012345678980

```

Figure 33: The Serial Output Configuration

## NOTE



The rows of numbers (0-80) above and below the data are not part of the printout. They are shown here for reference purposes only.

## SOFTWARE VERTICAL CALIBRATION

The Alpha-Step 200's vertical calibration can be adjusted by a factor of  $\pm 5$ -percent from the factory setting using a routine entered at the keyboard.

The vertical calibration software allows the user to enter a "desired reading" that will replace the currently displayed step height. The instrument computes the percentage difference between these values and uses it as a correction factor for all subsequent measurements.

This section tells how to enter the desired reading, and it suggests techniques that help in arriving at an accurate correction factor.

- This procedure requires a sample with a step of a known thickness, such as the calibration standard available from Tencor Instruments.
- The Instrument should be located in a quiet area and the isolation hood should be used to minimize acoustic and thermal effects.

## CALCULATING A CORRECTION FACTOR

- ① Clean the test surface and the stylus with alcohol.
- ② Scan the step and perform the mechanical leveling procedures.
- ③ Locate the step so that its distance from the stylus tip is 1/4 of the diameter of the stylus shank.
- ④ See the scan parameters for a scan of 400 micrometers at 1 sample per micrometer and take a scan.

## SECTION 5 -- MAINTENANCE

**NOTE**

Some of the procedures in the following sections require tools that are contained in the Maintenance Tool Kit (Model Number 10-02090). This kit can be ordered from Tencor Instruments. Consult Appendix B for ordering information.

### 5.1 PRINTER PAPER CHANGE

The printer paper should be replaced with paper available from Tencor Instruments (or an exact equivalent). To change the paper, follow these steps:

- ① Remove the printer cover by lifting at the front and disengaging the tab at the rear of the cover.
- ② Pull forward on the small lever located on the ~~right~~<sup>left side</sup> of the printer in front of the rubber roller. This will release any paper remaining in the printer.
- ③ Remove the old spool from the printer.
- ④ Place the new spool in the printer, orienting it so that the paper unwinds from underneath as it leaves the spool.

- 5 Insert the paper underneath the rubber roller from behind.

- This is easier if the end of the paper is cut so that it tapers to a point.

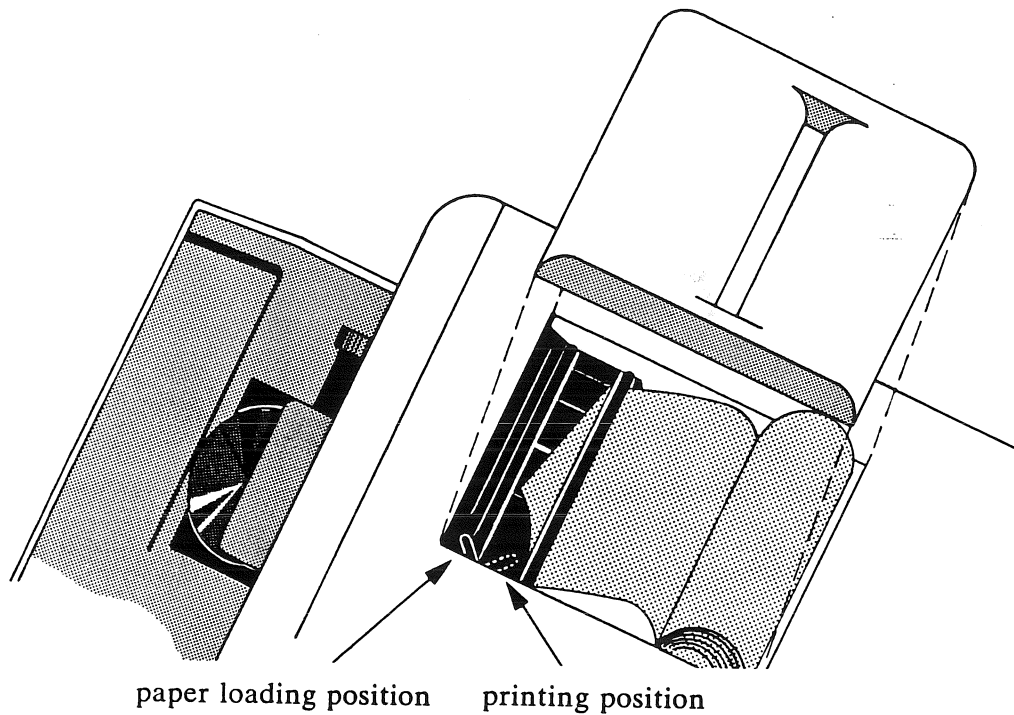

Figure 34: Loading Paper Into the Printer

- 6 The paper will emerge at the top of the rubber roller, aiming back. Pull out several inches of paper.
- 7 Check that the paper is correctly aligned and push the small lever back to engage the rubber roller against the paper.
- 8 Insert the paper edges into the top guides at the rear of the printer.

```

1234567891012345678920123456789301234567894012345678950123456789601234567897012345678980

10/26 11:37          ID #   0001
VERT.**50kA*         SCAN MENU 1
  L    5. A           um   s/um
  R -22.97kA
    -22.98kA*        2000 .2  1
Avg-11.89kA         **400**1* 5
TIR 22.99kA         80  5 25
Ra  9.445kA
HORIZ**100um        SCAN t= 8sec
  L 132.0um          DIR.-->
  R 174.0um
    *42.00um*        STYLUS 20mg
Area 6.8255         0 130um LEVEL
132.0um:  0.005  0.005  0.010  0.015  0.010  0.000 -0.015 -0.035 -0.070 -0.130
142.0um: -0.260 -0.480 -0.850 -1.415 -2.200 -3.225 -4.470 -5.900 -7.475 -9.155
152.0um: -10.90 -12.69 -14.47 -16.19 -17.80 -19.22 -20.40 -21.32 -21.98 -22.42
162.0um: -22.69 -22.84 -22.91 -22.94 -22.96 -22.96 -22.96 -22.96 -22.96 -22.97
172.0um: -22.97 -22.97 -22.97 -22.98 -22.98 -22.98 -22.98 -22.98 -22.98 -22.98
182.0um: -22.98 -22.97 -22.97 -22.98 -22.97 -22.97 -22.97 -22.97 -22.97 -22.98
192.0um: -22.98 -22.99 -23.00 -23.00 -23.00 -23.00 -22.99 -23.00 -22.99 -22.99
202.0um: -22.99 -22.99 -22.99 -22.99 -22.98 -22.97 -22.97 -22.96 -22.95 -22.94
212.0um: -22.94 -22.94 -22.93 -22.92 -22.91 -22.89 -22.87 -22.83 -22.76 -22.63
222.0um: -22.44 -22.17 -21.84 -21.49 -21.17 -20.93 -20.80 -20.82 -20.96 -21.20
232.0um: -21.48

```

---

```

1234567891012345678920123456789301234567894012345678950123456789601234567897012345678980

```

Figure 33: The Serial Output Configuration

## NOTE



The rows of numbers (0-80) above and below the data are not part of the printout. They are shown here for reference purposes only.

## SOFTWARE VERTICAL CALIBRATION

The Alpha-Step 200's vertical calibration can be adjusted by a factor of  $\pm 5$ -percent from the factory setting using a routine entered at the keyboard.

The vertical calibration software allows the user to enter a "desired reading" that will replace the currently displayed step height. The instrument computes the percentage difference between these values and uses it as a correction factor for all subsequent measurements.

This section tells how to enter the desired reading, and it suggests techniques that help in arriving at an accurate correction factor.

- This procedure requires a sample with a step of a known thickness, such as the calibration standard available from Tencor Instruments.
- The Instrument should be located in a quiet area and the isolation hood should be used to minimize acoustic and thermal effects.

## CALCULATING A CORRECTION FACTOR

- ① Clean the test surface and the stylus with alcohol.
- ② Scan the step and perform the mechanical leveling procedures.
- ③ Locate the step so that its distance from the stylus tip is 1/4 of the diameter of the stylus shank.
- ④ See the scan parameters for a scan of 400 micrometers at 1 sample per micrometer and take a scan.

**CAUTION**

Do not pull on the paper once the roller is engaged.

- 9 Replace the printer cover, threading the paper through the opening provided.

## 5.2 STYLUS FORCE ADJUSTMENT

The stylus force is shown in the screen's lower left corner. The reading is in milligrams. It can be adjusted over the range of 1 to 25 mg. Use the following procedures:

- 1 Place a substrate on the sample table.
- 2 Press and hold **TABLE ↑** until the table stops in the fully raised position.

**CAUTION**

Do not drive the table up to the stylus without a substrate on the sample table.

- 3 Lower the stylus to the sample.
- 4 Press **ENT**, then **VID**, then **TABLE ↑**. The table will rise and the stylus force will be displayed in the lower left corner of the screen.

- 5 Remove the black plug from the upper surface of the scanner cover using your fingernails. Insert a 0.050-inch hex key wrench into the stylus-force adjustment screw directly below the opening. Turning the screw clockwise increases the force.

**CAUTION**

Do not press **RESET** with the wrench inserted.

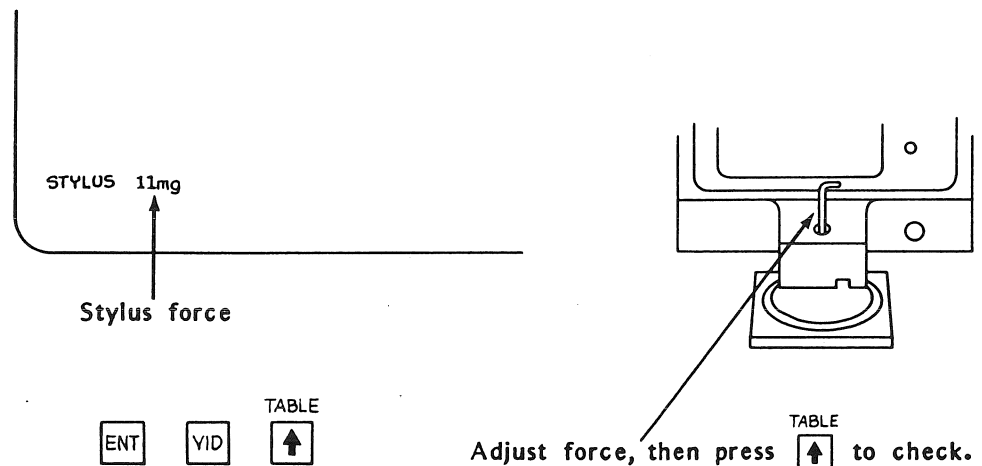

Figure 35: Adjusting the Stylus Force

- 6 Press **TABLE** with an upward arrow to measure the new stylus force.
- 7 Repeat the adjustment until the desired stylus force is obtained. When the adjustment is complete, replace the hole plug and press one of the following keys:
- VID** exits to the scan menu (Enter Mode) if in the Test Set Up.
  - ENT** Returns to normal operation, leaving the scan menu.
  - START STOP** initiates a new scan.



### 5.3 CHANGING THE STYLUS

Replacement styli of several sizes and a stylus insertion tool kit are available from Tencor instruments. To change the stylus:

- ❶ Lower the sample table by pressing **TABLE ↓**.
- ❷ Remove the scanner cover. It is held with two screws, recessed behind the small openings in the scanner cover. Loosen the screws using a 7/64-inch hex-key wrench (the screws will not fall out when loosened). Pull forward on the panel to remove it.
- ❸ The stylus is held in place with a 0-80 set screw in the right side of the stylus arm. Carefully loosen the set screw with a spline wrench. Do not apply pressure to the stylus arm. The spline wrench is light weight, so it can be left in the screw, for ❹.

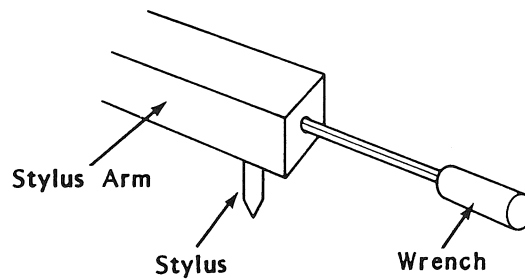

Figure 36: Changing the Stylus

- ④ If necessary, grasp the stylus with serrated tweezers and pull down to remove it. Store the stylus in its protective capsule for safe-keeping.
- ⑤ Place a mirror on the sample table to aid in viewing the stylus socket during insertion.
- ⑥ Hold the replacement stylus with serrated tweezers and carefully insert it into the stylus mounting socket on the underside of the stylus arm. The mounting socket can be observed in the mirror placed on the sample table.

**NOTE**

**Be certain that the stylus is fully inserted into the mounting socket.**

- ⑦ Tighten the set screw.
- ⑧ Replace the scanner cover, check the stylus force, and readjust, if necessary.

## 5.4 SHIPPING THE ALPHA-STEP 200

If the Alpha-Step 200 is to be shipped, use the original shipping crate or a replacement, which can be purchased from Tencor Instruments. Shipping in an unsuitable crate may cause damage.

- ① Place the protective plastic wrapper around the instrument to avoid contamination during shipping.
- ② Use the large strap to lower the instrument into the crate.
- ③ Lower the stage all the way down and carefully remove the rotary stage (vacuum stage for X-Y programmable option) and place in protective wrapping with accessories box.
- ④ Bring stage to center position and lower the stage so the stage base is about 3/8" above the enclosure.
- ⑤ Slide the front of the unit about 8" off the table and attach the two #8-32 x 1 3/8" phillips pan head screws through the two holes about 3" from the left and right edges.
- ⑥ Tighten the screws part way to begin to pull the measurement unit down against shipping locks.
- ⑦ Rotate the unit around so the back end is about 5" off the table.
- ⑧ Attach the 1/4-20 x 2.5 long phillips pan head screw into the hole near the center of the unit and pull the unit down until firmly against the shipping stop.
- ⑨ Rotate the unit 180-degrees again and completely tighten the two front hold-down screws. There should be about 1/8" clearance between the bottom of the table and the brown enclosure cover.
- ⑩ Put tape around knobs on the manual table to prevent any stage movement during shipping.

## SECTION 6 -- OPERATIONAL TOPICS AND THEORY

### 6.1 ACCURACY CONSIDERATIONS

Most surface features measured on a profilometer are much smaller vertically than they are horizontally. In plotting such features the vertical axis is exaggerated with respect to the horizontal axis by factors as large as 90,000 to 1. This horizontal compression is useful because it allows the entire step to be seen at one time. It does not affect measurement accuracy, since the Alpha-Step 200 labels both axes and provides a precise readout of cursor-derived measurements.

For example, as a typical stylus moves across a surface, it may encounter a physical feature like this:

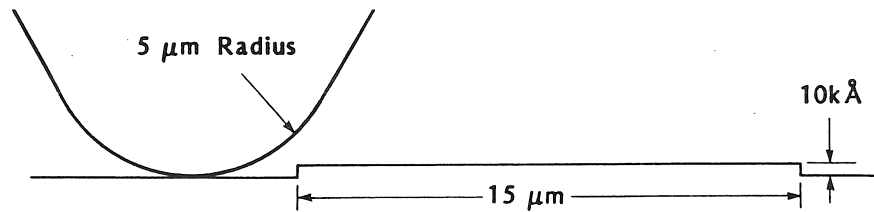
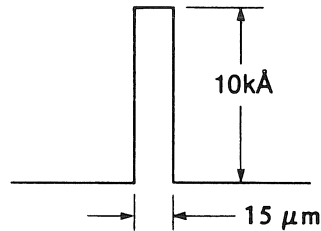

Figure 37: A Stylus Measures a Surface Characteristic

With a 1,000 x horizontal-to-vertical compression, the above surface would be displayed in this manner:

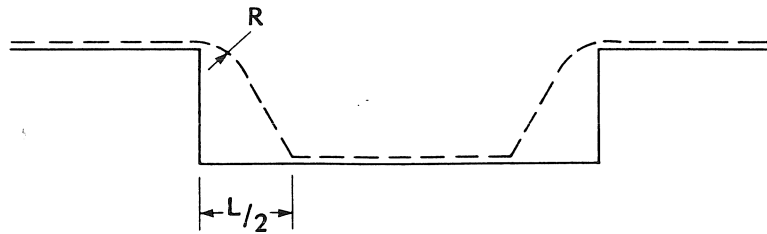

**Figure 38: The Effect of Compression on Display**

The pictorial representation of an artifact is affected by two factors: the dimensions of the stylus and the finite bandwidth of the instrument's circuitry. These factors can affect measurements of very fine-line geometries. One effect is an apparent loss of groove width and depth. Another is a rounding of profile features. These considerations are not significant as long as measurements are within the Alpha-Step 200's specified ranges. However, an understanding of these effects can help in realizing the instrument's full potential.

## 6.2 STYLUS SIZE

The size and shape of the stylus impose a lower limit to the size of the grooves to be measured. Ideally, the stylus should have a zero dimension horizontally. However, stress considerations require it to have some dimension. It can be modeled as a 60-degree cone rounded to a spherical tip with a  $12.5\ \mu\text{m}$  radius. The diagram below shows the path the stylus will follow in tracing a groove, where  $R$  is the radius of the stylus and  $L$  is the loss in groove width:



**Figure 39: The Importance of Stylus Shape on Dimensioning**

The stylus will follow a curve of radius  $R$  to a depth of  $R/2$  and then a 60-degree angle to the bottom of the groove. This reduces the apparent width of the groove being measured. The loss is most noticeable when the radius is large compared to the groove depth. The table and graph on the next page show the relationship between stylus radius and groove-width loss for a given groove depth.

Groove Width Loss, "L" ( $\mu\text{m}$ ) for Different Stylus Radii and Groove Depths

Stylus Radius ( $\mu\text{m}$ )	Groove Depth ( $\mu\text{m}$ )											
	.02	.05	.1	.2	.4	.8	1.6	2.5	5	10	20	25
12.5	1.4	2.2	3.2	4.5	6.3	8.8	12	15	20	26	38	43
5.0	.89	1.4	2.0	2.8	3.9	5.4	7.3	8.7	12	17	29	35
2.0	.56	.89	1.3	1.7	2.4	3.2	4.2	5.2	8.1	14	25	31
1.0	.40	.62	.87	1.2	1.6	2.1	3.0	4.0	6.9	13	24	30
0.4	.25	.39	.53	.69	.92	1.4	2.3	3.4	6.2	12	24	29
0.2	.17	.26	.35	.46	.69	1.2	2.1	3.1	6.0	12	23	29
0.0	.02	.06	.12	.23	.46	.92	1.9	2.9	5.8	12	23	29

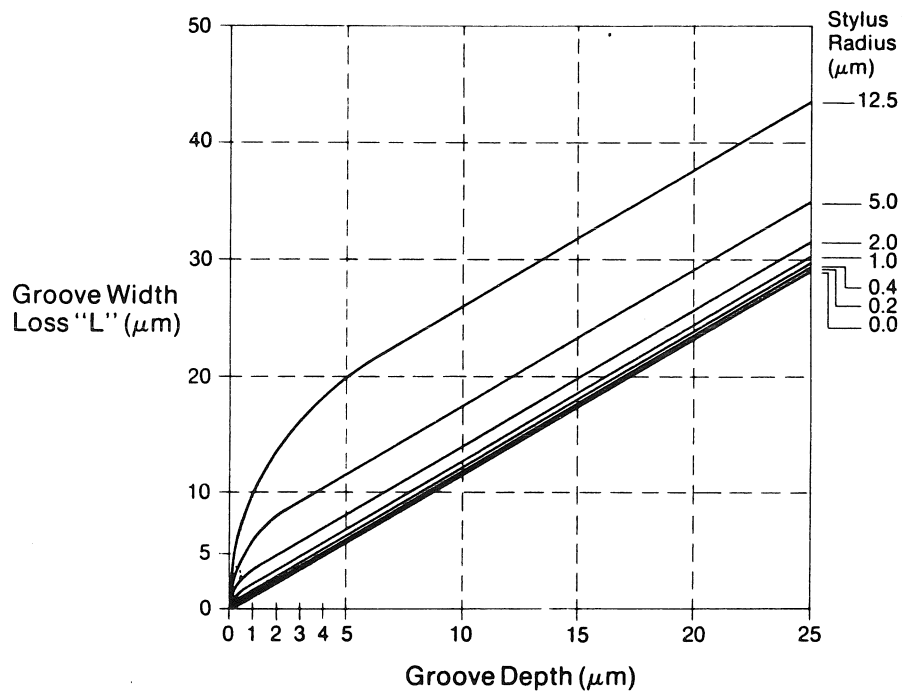

Figure 40: The Relationship Between Stylus Radius and Groove-width Loss

The important implication of these figures is that small radius styli should be used for substrates with very fine line widths. Optional styli are available with 1.5 to 2.5  $\mu\text{m}$  radii and with sub-micrometer radii.



### 6.3 FILTERING EFFECTS

The Alpha-Step 200 uses digital low-pass filtering to separate measurement data from unwanted noise. The filter removes both surface noise and electronic noise that would obstruct the measurement of actual surface features. Because this is a high-order filter, it can effectively eliminate noise with negligible effects on the measurements.

The digital filtering developed by Tencor Instruments is a significant advance over common electronic filtering. The filtering in the Alpha-Step 200 is a function of the horizontal dimensions of profile features. The filter's characteristics are precisely defined in terms that relate to the measurement being made. By contrast, simple electronic filtering is a function of frequency, which may not precisely relate to the profile's dimensions.

The digital filter is designed to pass surface variations that are larger than a certain horizontal dimension. Smaller features are greatly attenuated to reduce noise. The dimension of the smallest feature is a function of the sampling density: choosing a scan with more samples per micrometer allows smaller features to be plotted. The scan with the most samples per micrometer allows the instrument to achieve excellent resolution without having to turn off the filter. This avoids the undesirable noise tradeoff that turning off the filter may cause. This is particularly important in some operating environments, such as those with excessive vibration.

### 6.4 DEFEATING THE FILTER

As described in the previous section, low-pass filtering is used to reduce noise in measurements. In measuring very fine geometries this filtering might cause slight distortion of the data. The best technique for high-resolution measurement is to choose the scan length with the maximum number of samples per micrometer. If minimum distortion is required, it is possible to shut off the filter, although its noise-reducing benefits must be sacrificed.

When the instrument is powered up the low-pass filter is turned on.  
To turn off the filter:

- ① Press **[RESET]**, then **[ENT]**, then **[VID]**. The test set-up menu will be displayed.
- ② Press **[#]** to turn off the filter. If the filter is already off, pressing this key will turn it on again.
- ③ Press one of the following keys to exit the test set-up menu:

**[START STOP]** To exit and take a scan

**[VID]** To exit to the scan menu

**[ENT]** To exit to the Tencor Instruments logo (seen on power up)

- ④ Perform the measurement as described earlier in this manual. The 80  $\mu\text{m}$  scan with 25 samples per micrometer is recommended.

**NOTE**



Use the accessory isolation hood to provide acoustic and thermal isolation when making measurements at the highest magnifications.

The lower right-hand corner of the screen will display the message:

**FILTER OFF**

- ⑤ When measurements are complete, repeat ① through ③ to turn on the filter.

## 6.5 RANGE SELECTION

When the profile is plotted the Alpha-Step 200 horizontally and vertically autoranges to provide the maximum amount of magnification that the profile will allow.

- Moving the cursors, then pressing **[PLOT]** causes the instrument to choose the smallest horizontal range that is at least as long as the distance between the cursors.
- When replotting, the instrument chooses the shortest vertical range that accommodates the height of the profile section being displayed.
- When in the Enter Mode, the vertical range can be manually forced to change by pressing the **[RANGE ↑]** or **[RANGE ↓]** then **[PLOT]**.

The horizontal and vertical range selections are displayed in the data summary to the right of the labels **HORIZ** and **VERT**. The tables on the next page show the ranges that are available for any given scan.

Scan Length $\mu\text{m}$	Samples per $\mu\text{m}$	Horizontal Ranges $\mu\text{m}$						
10000	0.2	10000	5000	2000	1000	500	200	
2000	0.2	2000	1000	500	200			
	1	2000	1000	400	200	100	40	
400	1	400	200	100	40			
	5	400	200	80	40	20	8	
80	5	80	40	20	8			
	25	80	40	16	8	4	1.6	

Figure 41: Available Horizontal Range Selection

**Vertical Ranges**

<b>Vertical Mode: kiloÅngstroms</b>	<b>Vertical Mode: micrometers</b>
0.2	0.2
0.5	0.5
1	1
2	2
5	5
10	10
20	20
50	50
100	100
200	200
327	327

**Figure 42: Available Vertical Ranges**

## SECTION 7 -- PROGRAMMABLE X-Y STAGE OPTION

The X-Y Programmable Stage option for the Alpha-Step 200 Computerized Profiler stores nine stage positions in memory for recall by keyboard command. A programmable location parameter allows the operator to program the substrate locations which can be scanned either individually or in sequence automatically.

Servo motors driving the X and Y axes of the stage are controlled by the programmed location parameter or by four stage-direction keys. Using the instrument's memory and the stage servomechanism reduces operator fatigue and error by eliminating manual adjustment of the substrate location.

The Programmable X-Y Stage meets diverse requirements with three operating modes:

- Manual Mode for single scans
- Semiautomatic Mode for multi-point scans
- Automatic Mode

This section provides instructions for using the Programmable Stage. Refer to the main body of this manual for general operating instructions. Keys named are noted by brackets (e.g. NXT) to simplify commands. Keystrokes are always one at a time, never simultaneously.

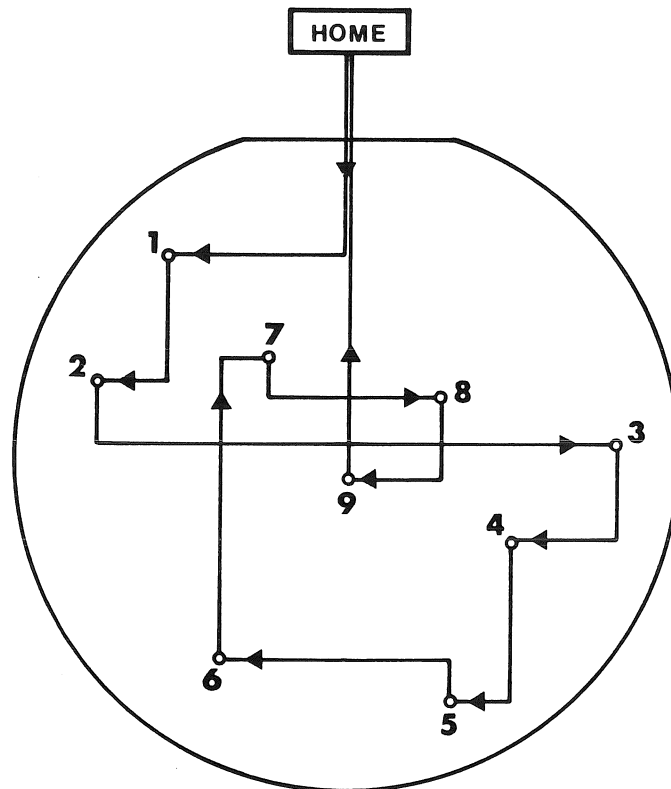

Figure 43: The Programmable Stage Allows Up to Nine Automatic Measurements

## 7.1 CONTROLS

### STAGE

When the profiler is first turned on, the stage automatically moves to the home position, shown in figure 44 (center and maximum distance from the chassis). This home position permits the operator to load or unload substrates easily. From any location, the stage can be returned to HOME by pressing **0** (the zero key on the numeric keypad).

The vacuum chuck holds the substrate during scans; the black toggle switch controls vacuum to the chuck. With the switch pointing away from the stage (as shown below), the substrate may be moved. With the switch pointing toward the stage, the chuck secures the substrate. Rotating the theta-lever adjusts the sample with respect to the X-Y coordinates of the sample stage.

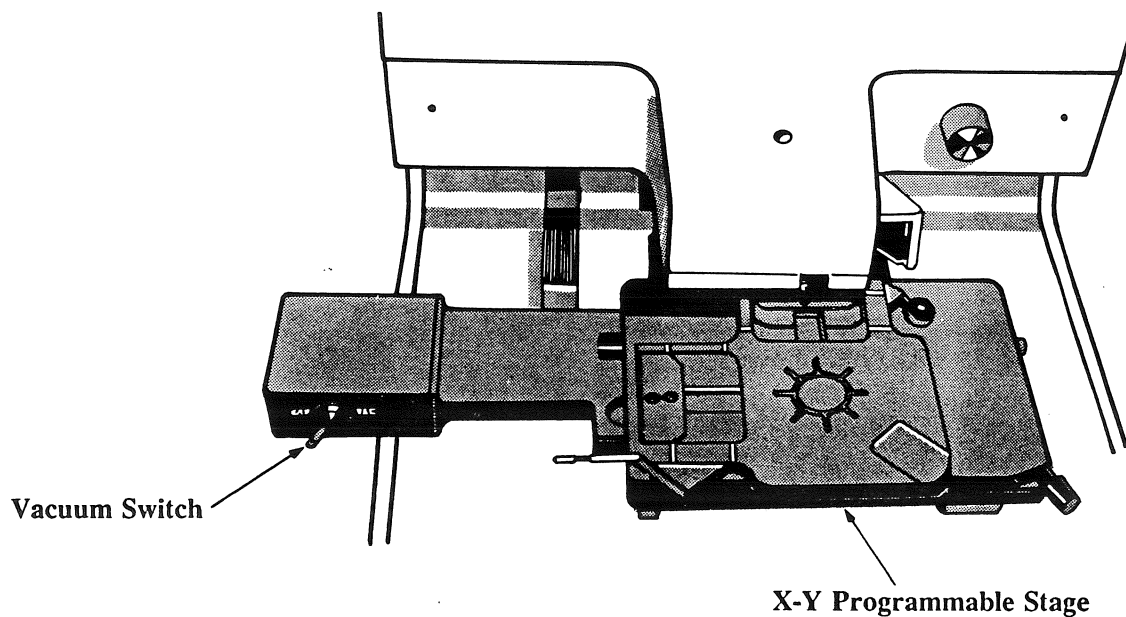

Figure 44: The X-Y Programmable Stage



## KEYBOARD

The Alpha-Step 200 keyboard for the X-Y Programmable Stage has five additional keys: **NXT** (for programming), **STAGE ↑**, **STAGE ↓**, **STAGE ←** and **STAGE →** (for controlling stage movement).

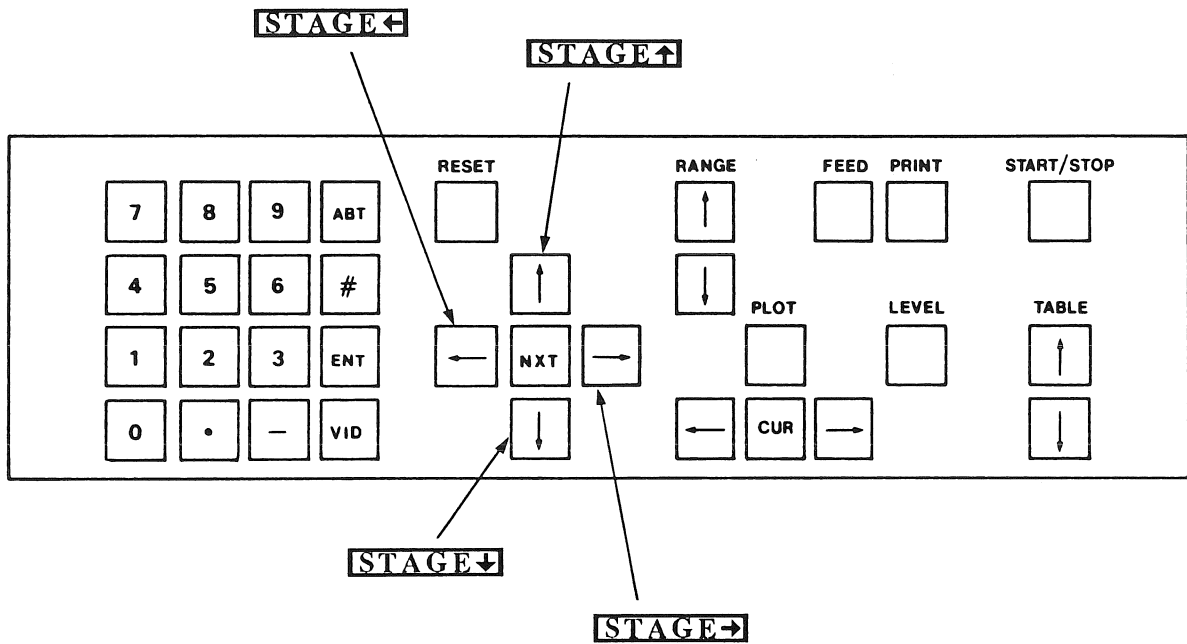

Figure 45: The Alpha-Step 200 Keyboard

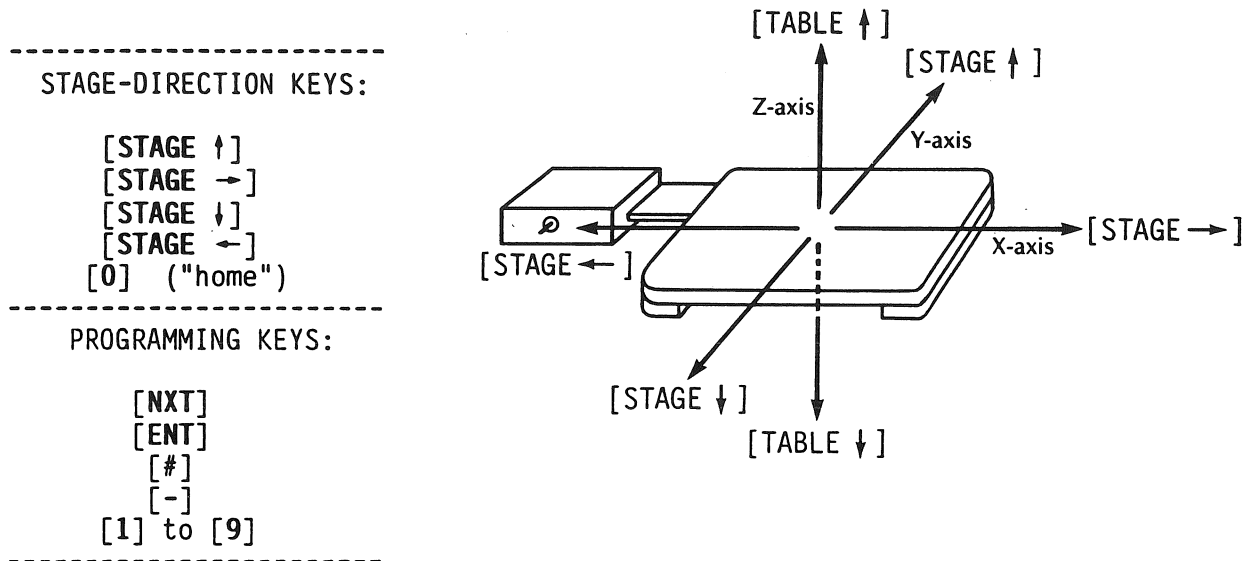
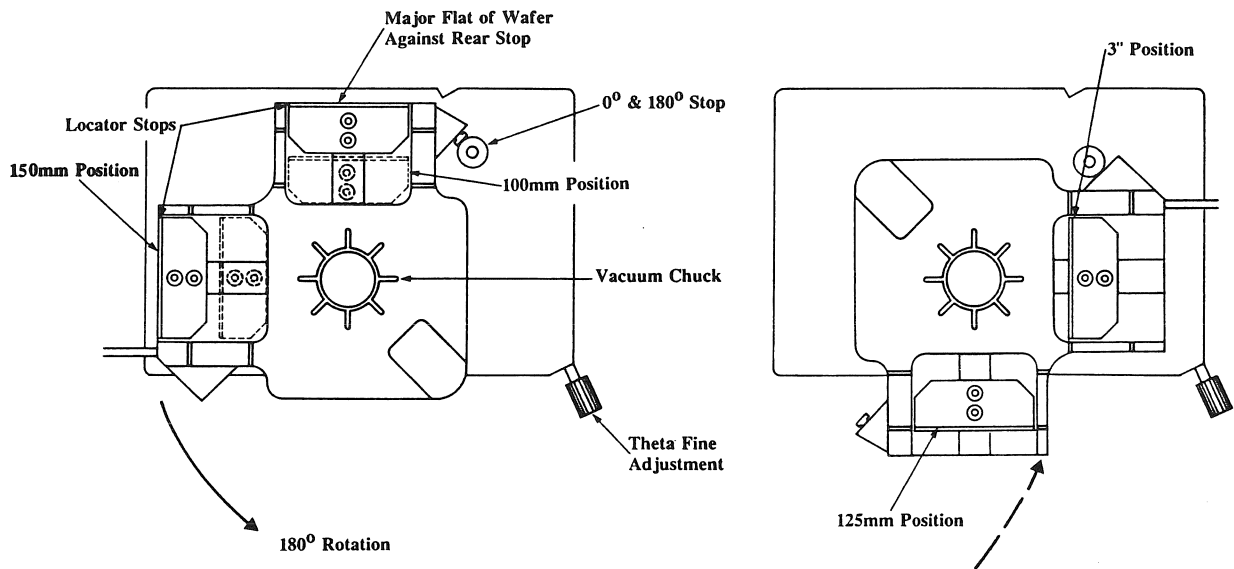

Figure 46: Controlling the X-Y Programmable Stage (Keyboard Commands)

## 7.2 SUBSTRATE LOCATOR BLOCKS

The substrate locator blocks must be set for the appropriate substrate size before scanning.



**Figure 47: The positions for 3", 100 mm, 125 mm substrates.**  
 Notice that the blocks for 3" and 100 mm substrates have the same position but with opposite orientation.

**NOTE**



To reverse the position of the blocks, slide them off the ends of the arms and replace them in the desired orientation.

## 7.3 OPERATION

The programmable stage has three operating phases:

- Substrate loading/unloading
- Scanning
- Programming

The first phase, loading or unloading a substrate to or from the stage, requires controlling the vacuum to the chuck.

Programming allows the operator to change the Scan Menus in three ways:

- Program a new location.
- Erase an existing programmed location.
- Change the location of an existing programmed location.

Within the scanning phase, three scan modes are possible:

- Manual Mode
- Semiautomatic Mode
- Automatic Mode

## 7.4 SUBSTRATE LOADING/UNLOADING

To prevent possible damage to the stylus, lower the stage (press **TABLE ↓**) before loading or unloading a substrate.

### CAUTION



Do not press **TABLE ↑** unless there is a substrate beneath the stylus.

Verify that the locator blocks are in the correct position (read "Substrate Locator Blocks").

To load a substrate press **[0]** to bring the stage HOME, turn the vacuum off and place the substrate on the vacuum chuck with the flat of the substrate against the rear locator block. Secure the substrate by turning the vacuum on.

To unload a substrate: press **[0]** to bring the stage "home," turn the vacuum off and remove the substrate.

## 7.5 SCANNING -- MANUAL MODE

The X-Y programmable stage can be positioned in Manual Mode by pressing and holding one of the stage-direction keys. (Note that, in the video image, the stylus appears to move in the opposite direction as the arrow.)

Two speeds in each direction are possible. Pressing the stage-direction key commands the stage to move at slow rate: 0.13 mm/sec. Pressing **[NXT]** and then the stage-direction key commands the stage to move at fast rate: 13 mm/sec.

### CAUTION



To prevent possible damage to the stylus, lower the stage (press **[TABLE ↓]**) before loading or unloading a substrate.

### CAUTION



Do not press **[TABLE ↑]** unless there is a substrate on the sample stage.

- ① Bring the stage home with **[0]**. Lower the stage completely with **[TABLE ↓]**. Load a substrate on the sample stage and move the stage with **[TABLE ↑]** until the substrate is beneath the stylus.
- ② Press and hold **[TABLE ↑]** until the substrate comes into view on the video microscope and the stylus rests on the surface of the substrate.
- ③ Use the stage-direction keys to move the substrate to the desired scan location. While the stage is moved in fast speed with the stage-direction keys, the stylus retracts to help prevent stylus damage from substrate surface features.

- ④ Press **[START STOP]** to take a scan. After the scan has been taken, the substrate may be moved to another location with the stage-direction keys.
- ⑤ To unload the substrate, press **[0]** to send the stage HOME. Unload the substrate (If a thicker substrate will be scanned next, lower the stage with **[TABLE ↓]**.)

## 7.6 PROGRAMMING

Before the instrument can be operated in Semiautomatic Mode or Automatic Mode, it must be programmed with the locations to be scanned. One unique location can be assigned to each of the nine Scan Menus so that each location is scanned according to specific measurement parameters. When a scan menu is programmed with a location, the SCAN MENU field is highlighted. Normal display of the SCAN MENU field indicates that the menu's location field has not been programmed. The instrument retains programmed location in the Scan Menus even after power is turned off -- the only way to erase a location from a menu is to remove it (see "Erasing a Programmed Location").

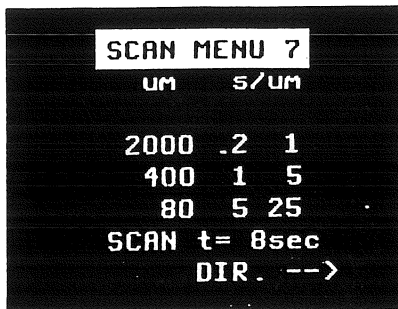

SCAN MENU 7

um	s/um	
2000	.2	1
400	1	5
80	5	25

SCAN t= 8sec  
DIR. -->

Figure 48: A Sample Scan Menu

## 7.7 PROGRAMMING A LOCATION

- ① Bring the stage HOME by pressing [0]. Lower the stage completely with **TABLE ↓** and load the substrate on the stage.
- ② Check that the location field of each scan menu is not presently programmed by pressing [1] through [9]. If a scan menu is programmed, the stage will go to that location. Before programming a new location for a scan menu, the old location must be erased (read "Erasing a Programmed Location").
- ③ Move the stage with **TABLE ↑** until the substrate is beneath the stylus. Press and hold **TABLE ↑** until the substrate comes into view on the video microscope and the stylus rests on the surface of the substrate.
- ④ With the stage-direction keys, move the stage to the desired location for the first scan and set the scan measurement parameters. Take a scan to verify the location and parameters.
- ⑤ Using "X" to represent the Scan-Menu number, press:

```
ENT  
then ≠  
then X  
then NXT
```

Programming scan menu "X" with the specified location so the instrument "remembers" the current location of the stage. If programmed correctly, the instrument will switch to the video image of the stylus and substrate. If the location is not accepted, press [0] to send the stage "home," and repeat ④ and ⑤.

- ⑥ Move the stage to the desired location for the next scan, set the scan parameters, and verify the position by taking a scan. Repeat ⑤, using a different digit to represent this different location. A maximum of nine locations can be programmed using these six steps.



## 7.8 ERASING A PROGRAMMED LOCATION

To erase a programmed location from scan menu "X", press:

**ENT**  
then **#**  
then **X**  
then **□**

The SCAN MENU field changes from a highlighted display to a normal display, indicating that the menu's location field is not programmed.

## 7.9 CHANGING A PROGRAMMED LOCATION

A location can easily be changed in a displayed SCAN MENU. First erase the programmed location. Then, without changing to a different scan menu, move the substrate to the new location and press:

**ENT**  
then **NXT**

In this special case of changing only the physical location of a programmed location, neither # nor "X" needs to be pressed.

## SEMIAUTOMATIC MODE

The sample stage can be commanded to move to a specific programmed location by pressing the number corresponding to the scan menu programmed with the location. After the stage is positioned, the scan can be initiated. If desired, the completed scan can be printed before moving the stage to another programmed location.

### CAUTION

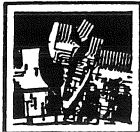

To prevent possible damage to the stylus, lower the stage (press **TABLE ↓**) before loading or unloading a substrate.

Do not press **TABLE ↑** unless there is a substrate on the sample stage.

- ① Bring the stage HOME by pressing **0**. Lower the stage completely with **TABLE ↓** and load the substrate.
- ② Press the scan menu number associated with the first location to be scanned (e.g. [1]). When the stage stops, press **TABLE ↑** to verify the starting location of the scan. If minor adjustment of the substrate is necessary, use the stage direction keys.
- ③ Press **START STOP** to start the scan.
- ④ Print the scan, if desired, by pressing **PRINT**.
- ⑤ Move to subsequent locations in numerical sequence (e.g. 2, then 3, then 4, etc.) by pressing

**NXT**  
then **#**

If the stage is already at the last programmed location of the sequence, it returns HOME.

The stage can be moved to any location out of the normal sequence by pressing the corresponding scan menu number (e.g. **1** through **9**) instead of **NXT** and then **#**.

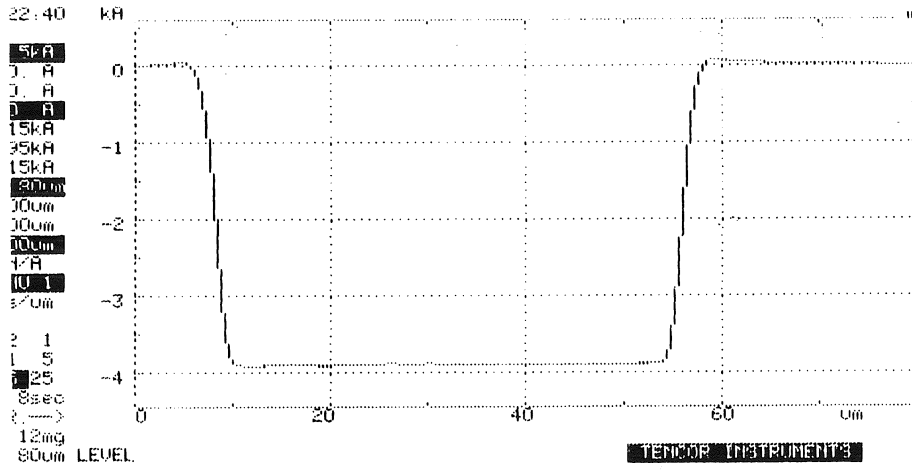

Figure 49: Sample Printout - Semiautomatic Mode (Shown Reduced)

## AUTOMATIC MODE

### TOGGLING AUTOPRINT

The AutoPrint feature enables printouts of scans taken in Automatic Mode to be generated automatically. When AutoPrint is ON, the printer automatically prints each scan taken in Automatic Mode. When AutoPrint is OFF, scans taken in Automatic Mode are not printed out. AutoPrint functions only during Automatic Mode; scans taken in Manual Mode or Semiautomatic Mode must be commanded manually with **PRINT**.

PARAMETER=		KEY=
DISPLAY=	NORMAL	ABT
	ANGLE	LUL
FILTER=	ON	#
AUTOPRINT=	ON	.

Figure 50: The Set-Up Menu

This feature may be toggled from the Set-up Menu. Press:

**RESET**  
**ENT**  
**VID**

to display the menu shown above. Press **.** (the period key) to toggle the AutoPRINT field ON or OFF. To save the Set-Up Menu with the change(s), press **ENT**.

## SCANNING IN AUTOMATIC MODE

After the locations are programmed into memory, the Alpha-Step 200 can operate in Automatic Mode. In this mode, the instrument sequentially measures all programmed locations without operator intervention.

To prevent possible damage to the stylus, lower the stage (press **TABLE ↓**) before loading or unloading a substrate.

Do NOT Press **TABLE ↑** unless there is a substrate on the sample stage.

- ① If the stage is not at HOME position, press **0**. Load the substrate.
- ② With the stage stopped at HOME position, press **START STOP**. The stage moves to the first programmed location and takes a scan. If AutoPrint is ON (read "Toggling Autoprint") the results are printed and the stage travels to the next programmed location. If AutoPrint is Off, the stage simply moves to the next programmed location. After the instrument completes the last scan of the sequence, the stage returns HOME and waits for the next command.

## APPENDIX A -- STATUS MESSAGES

### PLOT MAGNIFICATION

The distance between cursors must be less than the length of the next shorter horizontal range. See the section "Range Selection" for a list of ranges.

Cursors must have been moved into position; if they are left in position from aborting a zoom, pressing **PLOT** will not cause a zoom even if they are close enough together to fit within a shorter range. Move a cursor before replotting.

### STYLUS FORCE TOO LOW

Stylus may be stuck in either the up or down position. View through the windows on the scanner cover or with the video microscope. Adjust the stylus force if the stylus appears to be stuck. If this does not dislodge the stylus, contact Tencor Instruments.

### DATA OUT OF RANGE

#### DURING SCAN

Step height is greater than maximum measurement range:  $\pm 160 \text{ k}\text{\AA}$  in kiloÅngstrom mode,  $\pm 160 \text{ }\mu\text{m}$  in micrometer mode. Scan in micrometers if step is less than  $\pm 160 \text{ }\mu\text{m}$ . Choose a shorter scan length and position the scan to avoid unnecessarily large features.

#### DURING LEVELING

Position leveling cursors near feature of interest. Leveling may force other parts of the scan out of range, but if the step being measured is within range, the measurements will be accurate.

## DATA NOT LEVELED

Indicates that leveling has been aborted. This is merely a reminder of the leveling status -- it is not a warning. Leveling can be restored using the procedure in the "Leveling" sections of this manual.

## PRINTER DISCONNECTED

This message results from attempting to print on the remote printer when it is shut off or disconnected. Check the printer's connections and its power switch, then press **PRINT** again.

## FILTER OFF

Indicates that the digital low-pass filter has been defeated. The filter is used to remove noise from measurements. It should be turned off only when measuring very fine line geometries. The filter should be used for normal measurements. To turn on the filter, follow the procedures in the section "Defeating the Filter."

## REFERENCE (or) RAW DATA

Indicates that the instrument was left in a special service mode. The plot does not show measurement data if this message is displayed. To return to normal operation, press:

**RESET**  
**ENT**  
**VID**

and then press **ABT** until the screen shows the message:  
"NORMAL."

## PLEASE WAIT

This message is displayed for short periods while the instrument is performing internal operations, such as repositioning the stylus or sample table. The keyboard is inactive while the message is displayed.



# APPENDIX B -- ORDERING OPTIONS

## OPTIONS AND ACCESSORIES

- 10-02050 Programmable X-Y Stage Option (for new orders only).
- 10-02160 12X-to-36X Magnification Option (Replaces standard 40x-to-120x magnification. For new orders only.)
- 10-02170 90X-to-270X Magnification Option (Replaces standard 40X-to-120X magnification. For new orders only.)
- 10-02200 Disk Media Precision X-Y Stage Option.
- 70-00350 Remote CRT Module, 117 VAC, 60Hz. Allows simultaneous display of video microscope and scan data.

### INDIVIDUAL THIN FILM STANDARDS

SHS-0180A Calibration Standard, 180A  
SHS-0440A Calibration Standard, 440A  
SHS-0880A Calibration Standard, 880A  
SHS-4500A Calibration Standard, 4500A  
SHS-9400A Calibration Standard, 9400A

### SET OF FOUR THIN FILM STANDARDS

SHS-0002A Includes:

Calibration Standard, 440A  
Calibration Standard, 880A  
Calibration Standard, 4500A  
Calibration Standard, 9400A

### INDIVIDUAL THICK FILM STANDARDS:

SHS-0018M Calibration Standard, 18 $\mu$ m  
SHS-0080M Calibration Standard, 80 $\mu$ m  
SHS-2400M Calibration Standard, 24 $\mu$ m

### SET OF THREE THICK FILM STANDARDS

SHS-0003M Includes:

Calibration Standard, 18 $\mu$ m  
Calibration Standard, 80 $\mu$ m  
Calibration Standard, 24 $\mu$ m

- 10-02260 Replacement Scan Stylus, 25 Micrometer Radius.
- 10-00080 Replacement Scan Stylus, 12.5 Micrometer Radius.
- 10-00070 Replacement Scan Stylus, 5 Micrometer Radius.
- 10-00200 Replacement Scan Stylus, 1.5 -- 2.5 Micrometer Radius.
- 10-00085 Replacement Scan Stylus, Sub-Micrometer Radius. Includes SEM Documents.
- 10-02140 Isolation Hood.
- 10-02270 Accessory Tool Kit. Includes Stylus Insertion Kit and Maintenance Tool kit.
- 10-02080 String Drive Replacement kit.
- 10-02120 Thermal Printer Paper, Non-Lint-Free
- 10-02180 Thermal Printer Paper, Lint-Free
- 10-02100 Additional Alpha-Step 200 User's Manual.
- 10-02250 Alpha-Step 200 Clean Room User's Manual.
- 10-02110 Additional Alpha-Step 200 Quick Guide.
- 10-02290 Profiler Applications Handbook.



# INDEX

<b>Aborting</b>	
an entry.....	44
autoleveling.....	59
manual leveling.....	59
<b>Accuracy</b>	
discontinuities.....	3, 82
step height measurement.....	3
<b>Adjusting</b>	
leveling.....	60, 61
stylus, for uneven surfaces.....	5
stylus force.....	77, 78
<b>Area.....</b>	<b>8, 48, 62</b>
<b>Attaching</b>	
host computer.....	45
<b>Autoleveling.....</b>	<b>4, 20</b>
<b>AUTOLEVELING may now be changed.....</b>	<b>58</b>
<b>Automatic mode.....</b>	<b>98, 106</b>
programming.....	100, 102
scanning.....	107
toggling autoprint.....	106
<b>Autoprint.....</b>	<b>106</b>
<b>Autoranging.....</b>	<b>89</b>
limits.....	20
<b>Average</b>	
difference mode.....	53
calibrating in.....	74
repetitive scans.....	54, 55
profile height.....	5, 47, 48, 64
reference cursor.....	54, 55
roughness.....	5, 47
<b>Average difference mode.....</b>	<b>54</b>
<b>AVG.....</b>	<b>47, 48, 55, 64</b>
<b>Baud rate, printer.....</b>	<b>68</b>
<b>Brightness and contrast controls (display).....</b>	<b>19</b>
<b>Calculating a correction factor.....</b>	<b>72, 73</b>
<b>Calibrating in average difference mode.....</b>	<b>74</b>
<b>Changing</b>	
autoleveling.....	58
cursor speed.....	38
mode.....	30, 31
printer paper.....	75
programmed location.....	103

repeat count.....	64
sampling density.....	28
scan direction.....	20, 29
scan length.....	20, 28
scan menu.....	25
scan parameters.....	20, 27
serial output parameters.....	68
stylus.....	79, 80
units.....	30, 31
<b>Cleaning the stylus.....</b>	<b>72, 73</b>
<b>Clock</b>	
setting.....	67
<b>Components</b>	
9" video monitor.....	6
contrast and brightness controls.....	7, 19
keyboard.....	6
mechanical leveling adjustment.....	6
ON/OFF switch.....	7
rear panel.....	7
sample table (manual configuration).....	6
sample viewing windows.....	6
scanner cover.....	6
video microscope zoom knob.....	6
X- and Y-adjustments (manual configuration).....	6
<b>Compressing the display.....</b>	<b>84</b>
<b>Configuration, serial output.....</b>	<b>71</b>
<b>Consecutive scans.....</b>	<b>64</b>
<b>Contrast (display).....</b>	<b>7</b>
<b>Correction factor, vertical calibration.....</b>	<b>72</b>
<b>Critical calibration, minimizing effects of noise.....</b>	<b>5</b>
<b>Cross-sectional area.....</b>	<b>48</b>
<b>CUR.....</b>	<b>22</b>
<b>Cursors</b>	
activating.....	22
keyboard commands.....	22
positioning.....	22, 38
default.....	42
for uneven surfaces.....	5
two speeds.....	38
<b>Damaged shipment.....</b>	<b>13</b>
<b>Data</b>	
bits.....	69
calculating width from summary data.....	38
displaying.....	8, 11, 20
format.....	69
leveling.....	20, 57
maximum number of storage points.....	4, 5
printing.....	45, 46
sending.....	45, 46, 47
<b>Data not leveled.....</b>	<b>109</b>
<b>Data out of range.....</b>	<b>108</b>
<b>Data Send Mode</b>	
configuring.....	45
<b>DaV.....</b>	<b>55, 74</b>
<b>Default position.....</b>	<b>39</b>
<b>Defeating the filter.....</b>	<b>87, 88</b>

Delta average.....	48
Depth of Alpha-Step 200.....	12
Determining	
area.....	52
roughness.....	51
scan length and sampling rate.....	28
Diameter	
maximum sample diameter.....	11
Difference.....	55
Digital low-pass filtering.....	87
Digitally plotted profile.....	34
Dimensions.....	12
Direction of scan, changing.....	29
Display specifications.....	11
Displaying	
average height difference.....	65
features.....	23
print mode.....	46
profile data.....	62
slope measurement.....	62
short segment.....	63
summary data.....	47
vertical range.....	30
Disturbance, isolating from.....	3
Electronic noise	
removing with digital low pass filter.....	87
Enter mode	
default settings.....	27
exiting.....	44
terminating.....	27, 44
Entering	
correction factor.....	73
ID Numbers.....	44
parameters.....	29
Environment	
isolation from.....	14
temperature stability.....	14
Erasing a programmed location.....	103
Expanding profile data.....	4, 63
Field angle.....	63
FILTER OFF.....	88, 110
Filtering	
digital low pass to reduce unwanted noise.....	87
effects.....	87
Fine positioning.....	35
Force adjustment	
stylus.....	77
Force adjustment, stylus.....	11
Fujitsu (see printer).....	65
Graphical-centerline method.....	51
(see also surface roughness)	
Groove dimensions	
stylus considerations when measuring.....	86

Groove dimensions, stylus considerations .....	85
Height difference .....	55
High resolution measurement	
effects of noise .....	88
High resolution measurement, noise effects.....	87
Home position.....	98
HORIZ .....	37, 89
Horizontal cursor difference.....	23
Horizontal range.....	10, 41
selection.....	90
ID number.....	69
characters.....	44
entering.....	44
length.....	44
returning to.....	44
ID NUMBER may now be changed.....	44
Identifying printed output.....	23
Initiating	
data send.....	47
scan.....	35, 36
Installation	
rotary stage.....	15
standard configuration.....	13, 14
unpacking.....	13
vacuum chuck.....	16
Instrument table.....	14
Isolation hood.....	9
protecting scan from environmental noise.....	88
Keyboard.....	6, 9, 95
commands, X-Y programmable stage.....	96
controls	
programmable stage option.....	95
Leveling.....	56
automatic.....	20
specifications.....	11
completed ccan.....	38
completed scan.....	56
cursor.....	56
positions.....	24, 56
DEFAULT.....	56
cursor positions.....	59
data display.....	57
manual.....	11, 60
points	
storing.....	58
program.....	56
scan.....	56
Loading	
printer paper.....	76
sample.....	17, 18
Locating features	
Locator blocks	
positioning.....	98
Locking cursors	
to show deviation from a straight line when moved along a slope.....	63



Low pass filter	
defeating .....	87, 88
Magnification	
(also see Zoom)	
controlling with video microscope zoom knob .....	19
decreasing .....	34
increasing .....	34, 35
Magnifying scan features .....	4, 23, 40, 41
Maintenance tool kit .....	75
MANUAL LEVELING may now be changed .....	56
Manual mode .....	98
Manually leveling .....	60
Maximum sample dimensions .....	11
Measurement .....	4
cursor .....	39, 55
data	
cursor-derived .....	37
method of storage .....	37
horizontal .....	37
vertical .....	37
viewing .....	19
Measurements, programmable stage .....	93
Measuring	
area .....	52
average profile height .....	22, 37, 40, 49
bowed samples .....	60
profile features .....	37
rough or uneven surfaces .....	5
roughness .....	51
soft films .....	4
softbaked photoresist .....	4
surface characteristics .....	83
total indicated runout (TIR) .....	50
width of a feature .....	38
Mechanical disturbance, isolation from .....	3
Mechanical leveling adjustment .....	6, 60
Mode	
changing .....	31
automatic .....	106
semiautomatic .....	103
Moving	
cursors .....	22, 38
in tandem .....	38
separately .....	38
sample table .....	15, 17, 35
stylus .....	35
Multiple scan and average .....	64
to minimize noise .....	5
NBS traceability .....	4
No Autolevel .....	59
Noise	
isolation from .....	14
minimization .....	5
ON/OFF switch .....	7
Operating environment .....	14

Operating modes, programmable stage option	
automatic mode.....	92
manual mode.....	92
semiautomatic mode.....	92
Operating phases, programmable stage option.....	98
Output	
RS232C.....	71
specifications.....	11
Overriding autoranging.....	42
Parity.....	69
Physically leveling the sample.....	60
Pinout for RS232c.....	68
Please wait.....	110
Plot.....	21
plot magnification.....	108
plotting profile features.....	37, 40
Positioning	
cursors.....	22
level.....	59
magnify.....	23
measure step height.....	40
sample.....	20, 32, 35
video microscope image.....	19
Positions for 3", 100 mm, 125 mm substrates.....	97
Pre-positioning the leveling cursors.....	58
Preparation.....	14
Print option	
data send.....	45
screen.....	45
summary data.....	45
Printer	
communication configuration.....	69
interface baud rate.....	68
modes.....	45
output.....	11
paper	
aligning.....	76
changing.....	75
pinout.....	68
replacing.....	65
selection.....	65
specifications.....	12
Printer Disconnected.....	110
Printing	
data.....	23, 45, 46, 47
profile.....	45
scan results.....	47
Printout.....	105
Profile	
computing height.....	23, 37, 48
computing the cross-section.....	48
content.....	70
expanding.....	4
leveling a tilted profile.....	38
magnifying.....	4, 23, 40, 42
plotting.....	40

table	
specifics.....	70
Programmable Stage option.....	92, 94
connecting the power and vacuum.....	16
erasing an existing programmed location.....	98
keyboard commands.....	96
measurements.....	93
moving the stage.....	92
operation.....	98
programming.....	100, 102
programming a new location.....	98
scan modes	
automatic mode.....	98
manual mode.....	98
semiautomatic mode.....	98
vacuum chuck.....	16
Programmed functions.....	47
Programming a scan location.....	98, 100, 102
Providing maximum magnification.....	89
RA.....	47, 51
Method of determination.....	51
Raising the sample table.....	35
Range.....	3, 91
selection.....	89, 90
Raw data	
Re-leveling.....	4
Reading the data.....	20
Rear panel.....	7, 14
Reference data.....	110
Removing the rotary stage.....	15, 81
Repeat and Average.....	48, 55
REPEAT COUNT (X) may now be changed.....	64
Rescaling.....	4
Resolution	
Horizontal.....	10
increasing.....	28
Vertical.....	10
Restoring	
autoleveling.....	59, 60
Retracting the stylus.....	19
Return to the previous ID Number.....	44
Reversing stylus direction.....	35
Rotary stage	
installing.....	15
removing.....	15, 81
Rough or uneven surfaces.....	5
Roughness.....	51
Roundoff error.....	30
RS-232C.....	15, 45
Sample	
leveling specifications.....	11
maximum dimensions.....	11
positioning.....	32
stage movement specifications.....	11

viewing.....	6, 34
Sample Table.....	6
controlling.....	32, 35
moving.....	15
Sampling	
density.....	24, 28
rate.....	28
Saving scan menus.....	25
Scan	
aborting.....	36, 39
automatic mode.....	98
changing direction.....	20
direction.....	24, 29
length.....	20, 24, 28, 58
leveling.....	21, 38
magnifying features.....	23
manual mode.....	98
mechanics of.....	83
menu.....	20, 101
menus.....	25
positioning.....	39
programming locations.....	100, 102
semiautomatic mode.....	98
setting parameters.....	20
starting.....	36
stylus considerations.....	85
time.....	28, 69
viewing data.....	22
SCAN MENU may now be changed.....	25, 26, 28, 29, 31, 44, 46, 56, 58, 59
Scanner cover.....	6
Scanning	
automatic mode.....	107
identical samples.....	58
manual mode.....	99
programmable stage.....	98
semiautomatic mode.....	103
Screen Mode	
printing.....	46
Semiautomatic mode.....	98, 103
printing.....	105
programming.....	100, 102
Sending data.....	45, 46
Serial output configuration.....	15, 71
Serial Printer	
pinout.....	68
Service and maintenance.....	75
Set-up.....	14
Set-Up Menu.....	106
Setting	
clock.....	67
sampling density.....	28
scan direction.....	20
scan length.....	20, 28
scan parameters.....	20, 24
time.....	67
Setting scan parameters.....	24

Shading	8
indicating area.....	8
Shipping.....	13, 81
Shock/isolator mounts	
adding granite shielding.....	14
internal.....	14
Slope.....	48
analysis.....	63
definition.....	62
measurement.....	62
Small geometries.....	5
Soft films.....	4
Softbaked photoresist.....	4
Software vertical calibration, adjusting.....	72
Specifications.....	10
dimensions.....	12
display.....	11
electrical.....	12
horizontal ranges.....	10
maximum sample dimensions.....	11
output.....	11
printer.....	12
resolution.....	10
sample leveling.....	11
sample stage movement.....	11
scan method.....	11
stylus.....	10
stylus tracking force.....	11
vertical ranges.....	10
voltage.....	12
Stage	
controlling movement.....	11, 32, 33
home position.....	98
recalling programmed positions.....	92
Stage motion.....	32, 33, 96
Starting a scan.....	36
Status Message	
AUTOLEVELING may now be changed.....	58
CALIBRATION.....	73
CALIBRATION may now be changed.....	73
Data not leveled.....	109
Data out of range.....	108
DESIRED RDG.....	73
FILTER OFF.....	88, 110
ID NUMBER may now be changed.....	44
No Autolevel.....	59
Please wait.....	110
Plot Magnification.....	108
Printer disconnected.....	110
Reference data.....	110
REPEAT COUNT (X) may now be changed.....	64
SCAN MENU.....	101
SCAN MENU may now be changed.....	25, 26, 28, 29, 31, 44, 46, 56, 58, 59
Stylus force too low.....	108
Step height.....	37
measuring.....	40
Stop bits.....	69

Stopping a scan.....	36
Storing leveling points.....	58
<b>Stylus</b>	
changing.....	79, 80
cleaning.....	72, 73
dimensions.....	79, 85, 86
force adjustment.....	11, 77, 108
method of measurement.....	83, 85
mirror image.....	34
motion.....	29, 35, 36, 60
retracting.....	19
shape	
Importance of for dimensioning.....	85
sizes.....	80
specifications.....	10
viewing.....	34
Substrate loading/unloading.....	98
programmable stage.....	98
Substrate locator blocks.....	97
Substrates, positions for 3", 100 mm, 125 mm substrates.....	97
Summary data.....	38, 69
print modes.....	45
<b>Surface</b>	
average roughness.....	5
profile plot.....	21
removing noise with digital low pass filter.....	87
requirements.....	14
selecting features.....	70
viewing.....	34
Switching from k <sup>-</sup> to lm.....	30
Technical leveling adjustment.....	60
<b>Temperature</b>	
isolation.....	14
<b>Terminating</b>	
entry.....	27, 29, 44, 56
scan.....	36, 39, 58
from average difference mode.....	55
<b>Thermal disturbance</b>	
isolation from.....	3
<b>Thickness</b>	
maximum sample thickness.....	11
<b>Tilted profile.....</b>	<b>38</b>
causes.....	20
<b>Time</b>	
exiting from setting procedure.....	67
of scan.....	28
setting.....	67
<b>TIR.....</b>	<b>47, 50</b>
Toggling autoprint.....	106
Total indicated runout.....	47, 50
Ultra-sensitive measurement.....	88
Unloading a substrate.....	100
Unpacking.....	13
<b>Vacuum chuck</b>	
installing.....	16

removing.....	16
VERT.....	37, 42, 89
Vertical	
centering.....	43
range.....	30, 41, 91
resolution.....	10
units.....	24, 30, 31
Video	
magnification.....	34
microscope.....	34
microscope (positioning the sample).....	19
output.....	11
Video magnification.....	6
zoom specifications.....	5
Viewing	
sample.....	19
the measurement.....	19
the sample.....	34
Voltage Specifications.....	12
Weight of Alpha-Step 200.....	12
Width of Alpha-Step 200.....	12
X- and Y-Adjustments (manual configuration).....	6
X-adjustment knob.....	20, 35
X-axis	
stage movement.....	11
X-Y Programmable Stage option.....	2, 94
connecting the power and vacuum.....	16
keyboard commands.....	96
vacuum chuck.....	16
Y-adjustment knob.....	20, 33, 35
moving the table.....	17
Y-axis	
stage movement.....	11
Z-axis	
stage movement.....	11
Zoom.....	23, 40, 70
knob.....	34
optical specifications.....	5
previous magnification.....	42
undoing.....	42
Zoom knob.....	35





## TENCOR INSTRUMENTS SERVICE POLICY

---

The Tencor Instruments Service Organization is available to you in the United States, Europe, and Japan. We also have representatives in The People's Republic of China, Taiwan, Hong Kong, Singapore, and India. Your regional office is listed in the following pages.

Our commitment is to provide a technical response by telephone within 24 hours, often within the same business day. Our commitment for on-site repair is 48 hours.

- Our service organization is available for unpacking and installing your instrument. To schedule the installation, complete the Pre-Installation Qualification Form and contact the Customer Service Administrator at (800) 722-6775.
- In the United States we handle all service requests through a central number located in California. Call (800) 722-6775 Monday through Friday between 6:00 a.m. and 6:00 p.m. Pacific Standard Time to arrange for service or repair work or to order replacement parts.
- Standard on-site service hours are Monday through Friday, 8 a.m. to 5 p.m. local time. You can arrange for other hours through a customized service contract.
- We provide service beyond the original warranty period of 1 year as needed. Repair work that is done after the original warranty expires is guaranteed for 3 months. Full service contracts extend the warranty period and can be customized to your specific requirements.

We encourage you to attend a maintenance and repair training course for your instrument. In general, we find that better trained customers experience greater instrument up-time and make better use of our service resources. Your sales or service engineer can provide you with the course and fee schedule.

Model# 084999

Ser No 0184-564

D-0591-03

Software Ver

V3.7-2 © 1986-89

## PRINTER SETUP MENU

Baud Rate	9600
Data Bits	8
Stop Bits	1
Parity	NONE
End of Line	CR LF
End of Pg	----
Printer	ALPHA